



SERVICE MANUAL

UHF TRANSCEIVER

IC-F610

IC-F620

IC-F621

INTRODUCTION

This service manual describes the latest service information for the **IC-F610**, **IC-F620** and **IC-F621** UHF TRANSCEIVERS at the time of publication.

MODEL	VERSION	SYMBOL
IC-F610	Europe	EUR
	General	GEN
	Europe (MPT)	MTE
	General (MPT)	MTG
IC-F620	U.S.A.	USA
	U.S.A. (MPT)	MTU
IC-F621	U.S.A.	USA
	General	GEN

To upgrade quality, any electrical or mechanical parts and internal circuits are subject to change without notice or obligation.

DANGER

NEVER connect the transceiver to an AC outlet or to a DC power supply that uses more than 16 V. This will ruin the transceiver.

DO NOT expose the transceiver to rain, snow or any liquids.

DO NOT reverse the polarities of the power supply when connecting the transceiver.

DO NOT apply an RF signal of more than 20 dBm (100 mW) to the antenna connector. This could damage the transceiver's front end.



ORDERING PARTS

Be sure to include the following four points when ordering replacement parts:

1. 10-digit order numbers
2. Component part number and name
3. Equipment model name and unit name
4. Quantity required

<SAMPLE ORDER>

1110003490 S.IC TA31136FN IC-F610 MAIN UNIT 5 pieces
8810009990 Screw PH BT M3x8 ZK IC-F620 Bottom cover 10 pieces

Addresses are provided on the inside back cover for your convenience.

REPAIR NOTES

1. Make sure a problem is internal before disassembling the transceiver.
2. **DO NOT** open the transceiver until the transceiver is disconnected from its power source.
3. **DO NOT** force any of the variable components. Turn them slowly and smoothly.
4. **DO NOT** short any circuits or electronic parts. An insulated tuning tool **MUST** be used for all adjustments.
5. **DO NOT** keep power ON for a long time when the transceiver is defective.
6. **DO NOT** transmit power into a signal generator or a sweep generator.
7. **ALWAYS** connect a 50 dB to 60 dB attenuator between the transceiver and a deviation meter or spectrum analyzer when using such test equipment.
8. **READ** the instructions of test equipment thoroughly before connecting equipment to the transceiver.

EXPLICIT DEFINITIONS

FREQUENCY COVERAGE

L-band		400 – 430 MHz
M-band		440 – 490 MHz
H-band	H1-band	480 – 512 MHz
	H2-band	480 – 520 MHz

CHANNEL SPACING

Narrow/Wide-type	12.5 kHz / 25 kHz
Narrow/Middle-type	12.5 kHz / 20 kHz

TABLE OF CONTENTS

SECTION 1 SPECIFICATIONS

SECTION 2 INSIDE VIEW

SECTION 3 DISASSEMBLY INSTRUCTIONS

SECTION 4 CIRCUIT DESCRIPTION

4 - 1	RECEIVER CIRCUITS	4 - 1
4 - 2	TRANSMITTER CIRCUITS	4 - 2
4 - 3	PLL CIRCUITS	4 - 3
4 - 4	POWER SUPPLY CIRCUITS	4 - 4
4 - 5	PORT ALLOCATIONS	4 - 4

SECTION 5 ADJUSTMENT PROCEDURES

5 - 1	PREPARATION	5 - 1
5 - 2	PLL ADJUSTMENT	5 - 3
5 - 3	SOFTWARE ADJUSTMENT	5 - 4

SECTION 6 PARTS LIST

SECTION 7 MECHANICAL PARTS

SECTION 8 SEMI-CONDUCTOR INFORMATION

SECTION 9 BOARD LAYOUTS

9 - 1	FRONT UNIT	9 - 1
9 - 2	MAIN UNIT	9 - 3

SECTION 10 BLOCK DIAGRAM

SECTION 11 VOLTAGE DIAGRAMS

11 - 1	FRONT UNIT	11 - 1
11 - 2	MAIN UNIT	11 - 2

SECTION 1 SPECIFICATIONS

		USA/GEN	EUR	
GENERAL	Measurement method	EIA-152-C/204D or TIA-603	ETS 300 086	
	Frequency coverage	[L-band]: 400.000–430.000 MHz [M-band]: 440.000–490.000 MHz [H-band]: 480.000–512.000 MHz [USA], 480.000–520.000 MHz [EUR]/[GEN]		
	Type of emission	[N/W]: 8K50F3E/16K0F3E (12.5 kHz; Narrow/25 kHz; Wide), [N/M]: 8K50F3E/14K0F3E (12.5 kHz; Narrow/20 kHz; Middle)		
	Number of conventional channels	Max. 256 ch (16 channels × 16 banks), Max. 32 ch (MPT Trunking)		
	Power supply voltage (negative ground)	13.6 V DC nominal	13.2 V DC nominal	
	Current drain (approx.)	TX (at 25 W) 7.0 A [25W], (at 45 W) 13.0 A [45W] Rx (max. audio) 1200 mA (stand-by) 300 mA		
	Frequency error	2.5 ppm	±1.5 kHz	
	Usable temperature range	–30°C to +60°C (–22°F to +140°F)	–25°C to +55°C (–13°F to +131°F)	
	Dimensions (proj. not included)	140(W) × 40(H) × 170(D) mm; 5½(W) × 1⅞(H) × 6⅞(D) inch		
	Weight	1.2 kg; 2 lb 10 oz		
TRANSMITTER	RF output power	High/Low2/Low1: 25 W/10 W/2.5 W [25W], 45 W/25 W/4.5 W [45W]		
	Modulation system	Variable reactance frequency modulation		
	Maximum permissible deviation	±2.5 kHz [Narrow], ±4.0 kHz [Middle], ±5.0 kHz [Wide]		
	Spurious emissions	70 dBc typical	0.25 µW ≤ 1GHz, 1.0 µW > 1 GHz	
	Adjacent channel power	60 dB [Narrow], 70 dB [Middle]/[Wide]		
	Audio frequency response	+2 dB to –5 dB of 6 dB/octave range from 300 Hz to 2550 Hz [Narrow]/3000 Hz [Middle]/[Wide]		
	Audio harmonic distortion	3% typical at 1 kHz, 40% deviation		
	FM hum and noise (typical) (without CCICT filter)	40 dB [Narrow], 46 dB [Wide]	—	
	Residual modulation (typical) (with CCICT filter)	—	50 dB [Narrow], 53 dB [Middle], 55 dB [Wide]	
	Limiting charact of modulator	60–100% of max. deviation		
Microphone connector	8-pin modular (600 Ω)			
RECEIVER	Receive system	Double-conversion superheterodyne system		
	Intermediate frequencies	1st: 46.35 MHz, 2nd: 450 kHz		
	Sensitivity (typical)	0.25 µV at 12 dB SINAD	–4 dBµV (emf) at 20 dB SINAD	
	Squelch sensitivity (at threshold) (typical)	0.25 µV	–4 dBµV (emf)	
	Adjcent channel selectivity (typical)	65 dB [Narrow], 75 dB [Middle]/[Wide]		
	Spurious response	75 dB		
	Intermoduration (typical)	75 dB	67 dB	
	Hum and noise (typical)	(without CCITT filter)	40 dB [Narrow], 45 dB [Wide]	—
		(with CCITT filter)	—	50 dB [Narrow], 53 dB [Middle], 55 dB [Wide]
	Audio output power	4 W typical at 10% distortion with a 4 Ω load		
External SP connector	2-conductor 3.5 (d) mm (⅛")/4 Ω			

All stated specifications are subject to change without notice or obligation.

SECTION 2 INSIDE VIEW

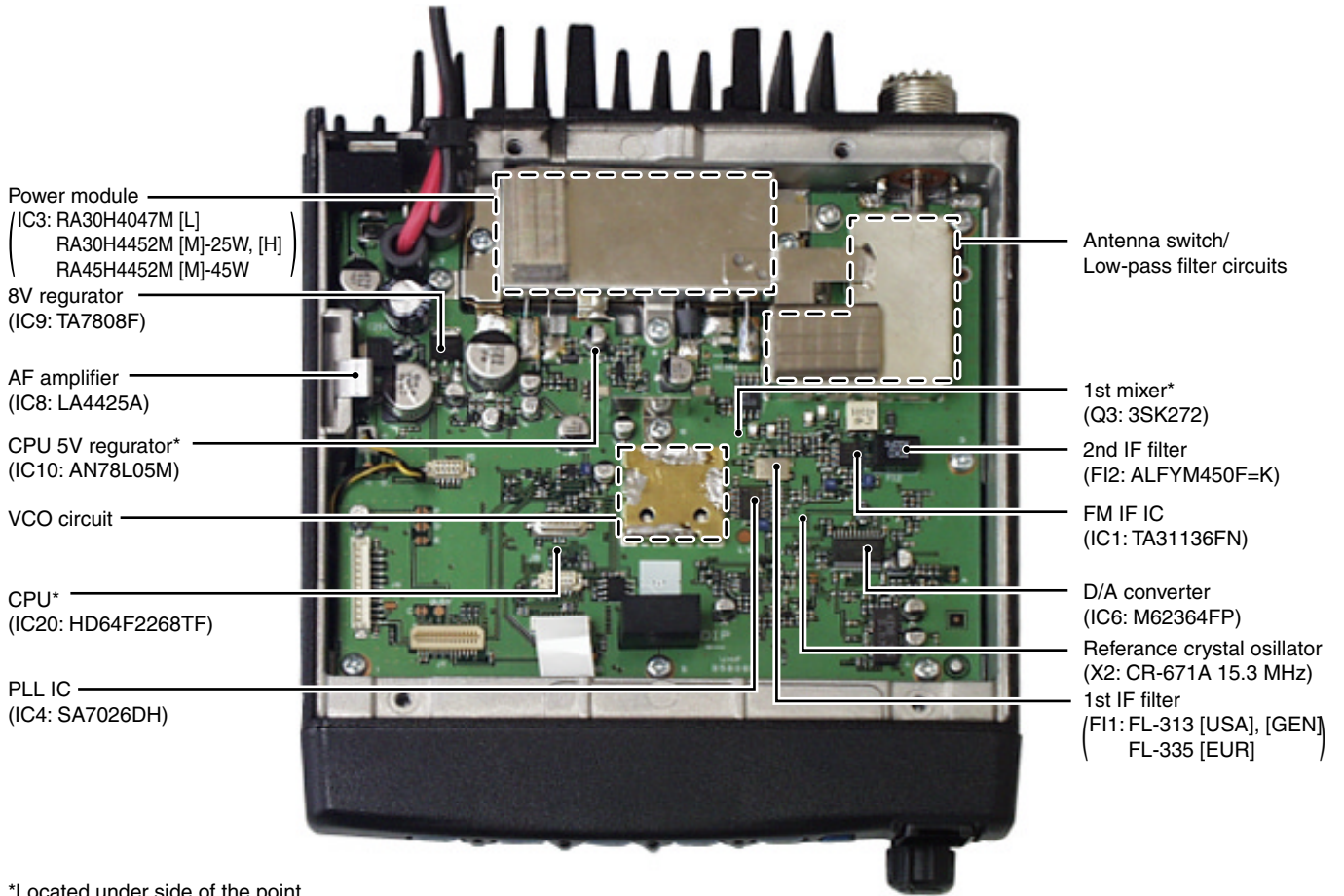

SECTION 3 DISASSEMBLY INSTRUCTIONS

• Opening case

- ① Unscrew 4 screws (A), and remove the bottom cover.
- ② Disconnect the flat cable (B) from J2.
- ③ Unscrew 2 screws (C), and remove the front unit.

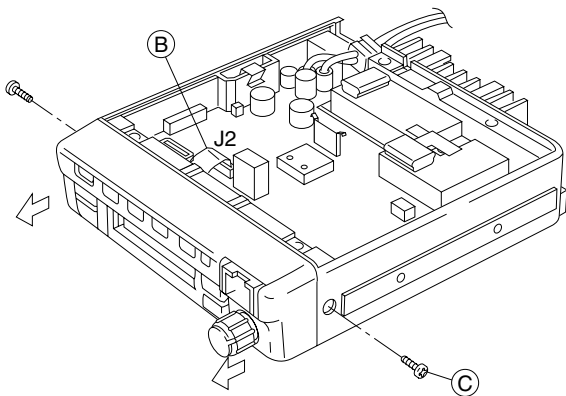
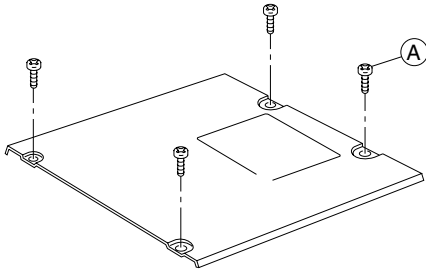

- ④ Unsolder 1 point (D) from the plate, and remove the plate.
- ⑤ Unsolder 3 points (E) from the antenna connector.
- ⑥ Remove the clip (F).
- ⑦ Disconnect the cable (G) from J5.
- ⑧ Unscrew 11 screws (H).

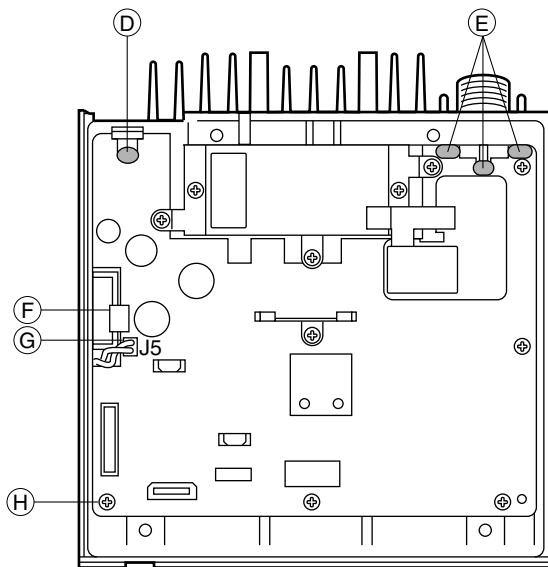

- ⑨ Lift up the front portion of the main unit and remove it.

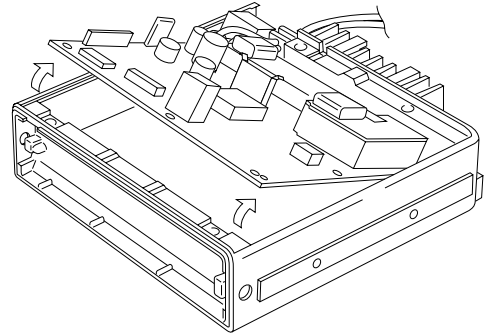

• Installation location

- | | |
|--------|-------------------------|
| UT-105 | SmarTrank2™ Logic Board |
| UT-108 | DTMF decoder unit |
| UT-109 | Voice scrambler unit |
| UT-110 | |
| UT-111 | Trunking unit |

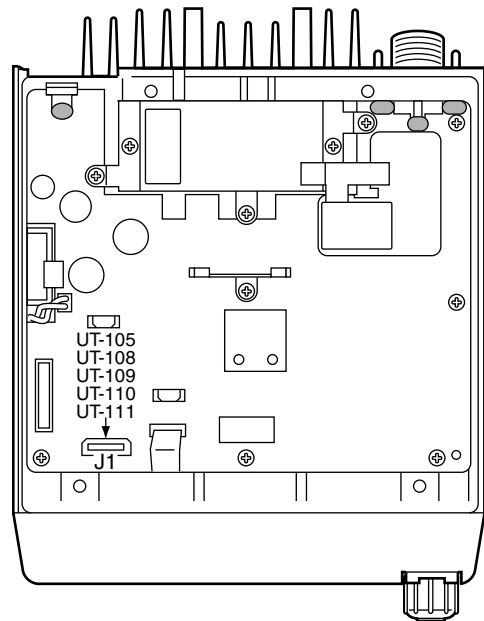

SECTION 4 CIRCUIT DESCRIPTION

4-1 RECEIVER CIRCUITS

4-1-1 ANTENNA SWITCHING CIRCUIT (MAIN unit)

The antenna switching circuit functions as a low-pass filter while receiving and as resonator circuit while transmitting. The circuit does not allow transmit signals to enter receiver circuits.

Received signals enter the antenna connector and pass through the low-pass filter (L1–L3, C1, C2, C6–8, C16). The filtered signals are then applied to the RF circuit passed through the $\lambda/4$ type antenna switching circuit (D5, D6, L6).

4-1-2 RF CIRCUIT (MAIN unit)

The RF circuit amplifies signals within the range of frequency coverage and filters out-of-band signals.

The signals from the antenna switching circuit pass through the two-stage tunable bandpass filters (D8, D4). The filtered signals are amplified at the RF amplifier (Q2) and then enter other two-stage bandpass filters (D9, D10) to suppress unwanted signals. The filtered signals are applied to the 1st mixer circuit (Q3).

The tunable bandpass filters (D4, D8–D10) employ varactor diodes to tune the center frequency of the RF passband for wide bandwidth receiving and good image response rejection. These diodes are controlled by the CPU (IC20) via the D/A converter (IC7).

The gate control circuit reduces RF amplifier gain and attenuates RF signal to keep the audio output at a constant level.

The receiver gain is determined by the voltage on the “RSSI” line from the FM IF IC (IC1, pin 12). The gate control circuit supplies control voltage to the RF amplifier (Q2) and sets the receiver gain.

When receiving strong signals, the “RSSI” voltage increases and the gate control voltage decreases. As the gate control voltage is used for the bias voltage of the RF amplifier (Q2), then the RF amplifier gain is decreased.

4-1-3 1ST MIXER AND 1ST IF CIRCUITS (MAIN unit)

The 1st mixer circuit converts the received signals to a fixed frequency of the 1st IF signal with the PLL output frequency. By changing the PLL frequency, only the desired frequency will pass through a MCF (Monolithic Crystal Filter; F11) at the next stage of the 1st mixer.

The RF signals from the bandpass filter are applied to the 1st mixer circuit (Q3). The applied signals are mixed with the 1st LO signal coming from the RX VCO circuit (Q13) to produce a 46.35 MHz 1st IF signal. The 1st IF signal passes through a MCF (Monolithic Crystal Filter; F11) to suppress out-of-band signals. The filtered signal is amplified at the 1st IF amplifier (Q4) and applied to the 2nd IF circuit.

4-1-4 2ND IF AND DEMODULATOR CIRCUITS (MAIN unit)

The 2nd mixer circuit converts the 1st IF signal to a 2nd IF signal. A double-conversion superheterodyne system improves the image rejection ratio and obtains stable receiver gain.

The 1st IF signal from the 1st IF amplifier (Q4) is applied to the 2nd mixer section of the FM IF IC (IC1, pin 16) and is then mixed with the 2nd LO signal for conversion to a 450 kHz 2nd IF signal.

IC1 contains the 2nd mixer, limiter amplifier, quadrature detector, active filter and noise amplifier circuits, etc. A tripled frequency from the PLL reference oscillator is used for the 2nd LO signal (45.9 MHz).

The 2nd IF signal from the 2nd mixer (IC1, pin 3) passes through a ceramic filter (F12) to remove unwanted heterodyned frequencies. It is then amplified at the limiter amplifier section (IC1, pin 5) and applied to the quadrature detector section (IC1, pins 10, 11 and X1) to demodulate the 2nd IF signal into AF signals.

The AF signals are output from pin 9 (IC1) and are then applied to the AF amplifier circuit.

• 2nd IF and demodulator circuits

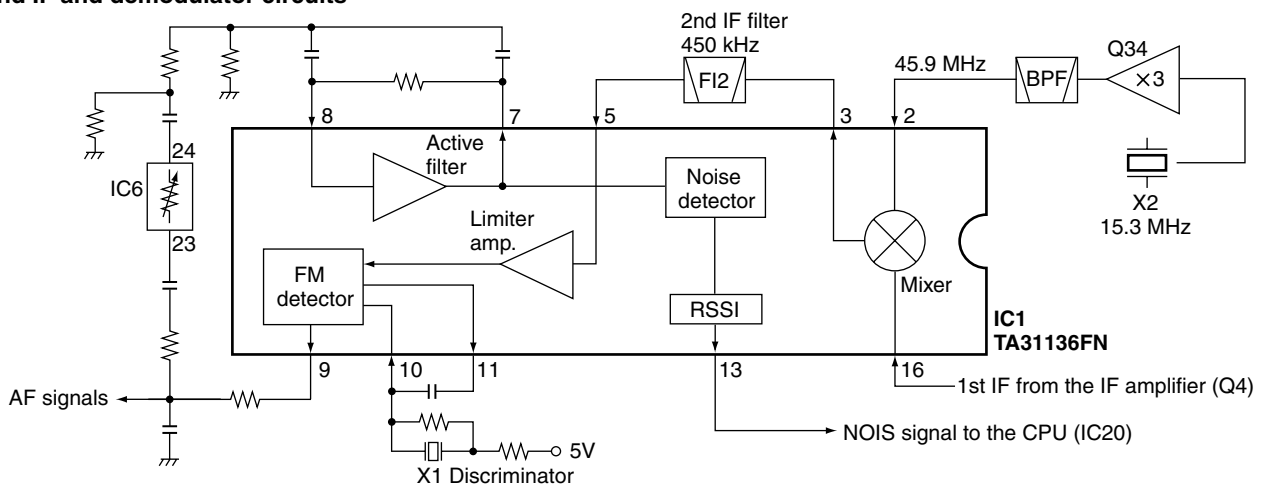

4-1-5 AF AMPLIFIER CIRCUIT (MAIN unit)

The AF amplifier circuit amplifies the demodulated AF signals to drive a speaker.

The AF signals from the FM IF IC (IC1, pin 9) are amplified at the AF amplifier section of the compander IC (IC14, pins 5, 4) and are then applied to the high-pass filter circuit (IC21b).

The high-pass filter characteristics are controlled by the FSW signal from the LCD driver IC (FRONT unit; IC1, pin 6). When FSW signal is high, the cut-off frequency is shifted higher to remove CTCSS or DTCS signals.

The filtered AF signals from the high-pass filter (IC21b, pin 7) are applied to the de-emphasis section of compander IC (IC14, pin 3) with frequency characteristics of -6 dB/octave, and are then passed through the low-pass filter, high-pass filter, expander sections of compander IC (IC14). The output signal from IC14 (pin 38) is applied to the electronic volume controller (IC6, pin 1).

The output AF signals from the electronic volume controller (IC6, pin 2) are applied to the AF amplifier (IC18) and AF power amplifier (IC8) to drive the speaker.

4-1-6 RECEIVER MUTE CIRCUITS (MAIN unit)

• NOISE SQUELCH

The noise squelch circuit cuts out AF signals when no RF signals are received. By detecting noise components in the AF signals, the squelch circuit switches the AF mute switch.

Some noise components in the AF signals from the FM IF IC (IC1, pin 9) are passed through the level controller (IC6, pins 24, 23). The level controlled signals are applied to the active filter section in the FM IF IC (IC1, pin 8). Noise components about 10 kHz are amplified and output from pin 7.

The filtered signals are converted into the pulse-type signals at the noise detector section and output from pin 13 (NOIS).

The NOIS signal from the FM IF IC is applied to the CPU (IC20, pin 37). The CPU then analyzes the noise condition and controls the AF mute signal via "AFON" line (IC20, pin 18) to the AF regulator (Q39, Q40, D31).

• CTCSS AND DTCS

The tone squelch circuit detects AF signals and opens the squelch only when receiving a signal containing a matching subaudible tone (CTCSS or DTCS). When tone squelch is in use, and a signal with a mismatched or no subaudible tone is received, the tone squelch circuit mutes the AF signals even when noise squelch is open.

A portion of the AF signals from the FM IF IC (IC1, pin 9) passes through the low-pass filter (IC5) to remove AF (voice) signals and is applied to the CTCSS or DTCS decoder inside the CPU (IC20, pin 46) via the "CDEC" line to control the AF mute switch.

4-2 TRANSMITTER CIRCUIT

4-2-1 MICROPHONE AMPLIFIER CIRCUIT (MAIN unit)

The microphone amplifier circuit amplifies audio signals within $+6$ dB/octave pre-emphasis characteristics from the microphone to a level needed for the modulation circuit.

The AF signals (MIC) from the FRONT unit via J2 (pin 1) are passed through the level controller (IC6, pins 9, 10) to the microphone amplifier circuit.

The AF signals from the level controller (IC6) are applied to the microphone amplifier section of compander IC (IC14, pin 12). The amplified signals are passed through the compressor, low-pass filter and high-pass filter sections of IC14.

The filtered AF signals are amplified at the buffer amplifier (Q21) and pre-emphasized with $+6$ dB/octave at the pre-emphasis circuit (R122, C187), and are then applied to the IDC amplifier section of IC14 (pin 8).

The amplified AF signals are passed through the limiter amplifier, low-pass filter and smoothing filter sections of IC14 after being passed through the AF mute switch inside of IC14.

The output signals from pin 6 are passed through the analog switch (IC15), splatter filter (IC21d) and applied to the level controller (IC6, pins 21, 22). The deviation level controlled signals are then applied to modulation circuit as the "MOD" signal.

The narrow/wide switch (Q22) is connected to the input of the splatter filter (IC21d) and switched by the "NWC" signal coming from the CPU (IC20, pin 19). When "NWC" is at a high level, the narrow/wide switch (Q22) shifts the filter cut-off frequency for narrow deviation selection.

4-2-2 MODULATION CIRCUIT

The modulation circuit modulates the VCO oscillating signal (RF signal) using the microphone audio signals.

The AF signals from the level controller (IC6, pin 22) change the reactance of varactor diode (D18) to modulate the oscillated signal at the TX VCO circuit (Q14, D17). The modulated VCO signal is amplified at the buffer amplifiers (Q11, Q10) and is then applied to the drive amplifier circuit via the T/R switch (D14).

The CTCSS/DTCS signals from the CPU (IC20, pins 89–91) are passed through the low-pass filter (Q37), level controller (IC6, pins 12, 11) and mixer (IC21a), and are then applied to the VCO circuit via the splatter filter (IC21d).

4-2-3 DRIVE AMPLIFIER CIRCUIT (MAIN unit)

The drive amplifier circuit amplifies the VCO oscillating signal to the level needed at the power amplifier.

The RF signal from the buffer amplifier (Q10) passes through the T/R switch (D14) and is amplified at the YGR (Q9) and pre-drive (Q8) amplifiers. The amplified signal is applied to the power amplifier circuit.

4-2-4 POWER AMPLIFIER CIRCUIT (MAIN unit)

The power amplifier circuit amplifies the driver signal to an output power level.

The RF signal from the pre-drive amplifier (Q8) is applied to the power module (IC3) to obtain 25 W for IC-F610/F620, or 45 W for IC-F621 of RF power.

The amplified signal is passed through the antenna switching circuit (D2), low-pass filter and APC detector, and is then applied to the antenna connector.

Control voltage for the power amplifier (IC3, pin 3) comes from the APC amplifier (IC2) to stabilize the output power. The transmit mute switch (D32) controls the APC amplifier when transmit mute is necessary.

4-2-5 APC CIRCUIT (MAIN unit)

The APC circuit protects the power amplifier from a mismatched output load and stabilizes the output power.

The APC detector circuit detects forward signals and reflection signals at D11 and D1 respectively. The combined voltage is at minimum level when the antenna impedance is matched at 50 Ω, and is increased when it is mismatched.

The detected voltage is applied to the APC amplifier (IC2, pin 3), and the power setting "T4" signal from the D/A converter (IC7, pin 4), controlled by the CPU (IC20), is applied to the other input for reference. When antenna impedance is mismatched, the detected voltage exceeds the power setting voltage. Then the output voltage of the APC amplifier (IC2, pin 4) controls the input current of the power module (IC3) to reduce the output power.

4-3 PLL CIRCUITS

4-3-1 PLL CIRCUIT

A PLL circuit provides stable oscillation of the transmit frequency and receive 1st LO frequency. The PLL output compares the phase of the divided VCO frequency to the reference frequency. The PLL output frequency is controlled by the divided ratio (N-data) of a programmable divider.

The PLL circuit contains the TX/RX VCO circuit (Q14, Q13). The oscillated signal is amplified at the buffer amplifiers (Q11, Q12) and then applied to the PLL IC (IC4, pin 5) via the low-pass filter (L32, C298, C299).

The PLL IC contains a prescaler, programmable counter, programmable divider and phase detector, etc. The entered signal is divided at the prescaler and programmable counter section by the N-data ratio from the CPU. The reference signal is generated at the reference oscillator (X2) and is also applied to the PLL IC. The PLL IC detects the out-of-step phase using the reference frequency and outputs it from pin 9. The output signal is passed through the loop filter and is then applied to the VCO circuit as the lock voltage.

If the oscillated signal drifts, its phase changes from that of the reference frequency, causing a lock voltage change to compensate for the drift in the oscillated frequency.

4-3-2 VCO CIRCUIT

The VCO circuit contains a separate RX VCO (Q13, D16) and TX VCO (Q14, D17, D18). The oscillated signal is amplified at the buffer amplifiers (Q11, Q10) and is then applied to the T/R switch circuit (D14, D15). Then the receive 1st LO (Rx) signal is applied to the 1st mixer (Q3) and the transmit (Tx) signal to the YGR amplifier circuit (Q9).

A portion of the signal from the buffer amplifier (Q11) is fed back to the PLL IC (IC4, pin 5) via the buffer amplifier (Q12) and low-pass filter (L32, C298, C299) as the comparison signal.

• PLL circuit

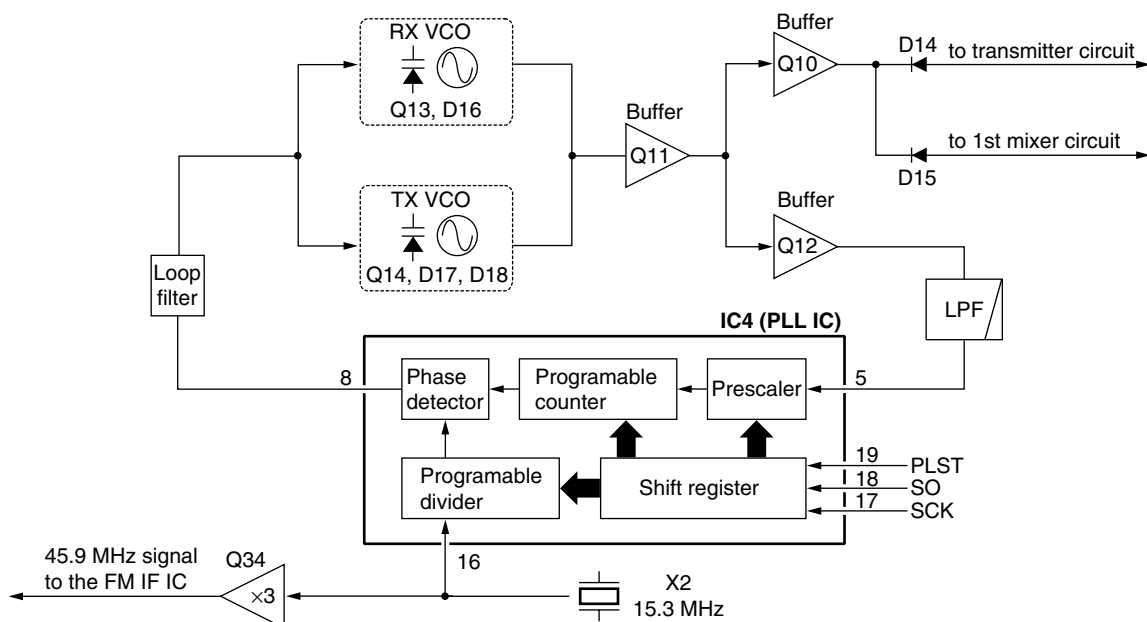

4-4 POWER SUPPLY CIRCUITS

4-4-1 VOLTAGE LINES (MAIN unit)

Line	Description
HV	The voltage from a DC power supply.
VCC	The same voltage as the HV line which is controlled by the power switching circuit (Q23, Q24). When the [POWER] switch is pushed, the CPU outputs the "PWON" control signal to the power switching circuit to turn the circuit ON.
CPU5V	Common 5 V for the CPU converted from the HV line by the CPU5V regulator circuit (IC10). The circuit outputs the voltage regardless of the power ON/OFF condition.
8V	Common 8 V converted from the VCC line by the 8V regulator circuit (IC9).
5V	Common 5 V converted from the VCC line by the 5V regulator circuit (Q27, Q28).
R8V	Receive 8 V controlled by the R8 regulator circuit (Q26, Q30, D24) using the "TXC" signal from the CPU (IC20, pin 16).
T8V	Transmit 8 V controlled by the T8 regulator circuit (Q25, Q29, D23) using the "TMUT" signal from the CPU (IC20, pin 17).

4-5 PORT ALLOCATIONS

4-5-1 OUTPUT EXPANDER (FRONT unit; IC1)

Pin number	Port name	Description
1-3	KS0-KS2	Output ports for key matrix.
4	DIM1	Outputs LCD backlight control signal. Low : While LCD backlight is dim.
5	DIM2	Outputs LCD backlight control signal. Low : While LCD backlight is OFF.
6	FSW	Outputs high-pass filter's characteristics select signal.
7	HORN	Outputs external device control signal. High : When matched 2/5-tone signals are received.
12-55	SEG1-SEG40, COM1-COM4	Output ports for LCD control signal.

4-5-2 OUTPUT EXPANDER (MAIN unit; IC7)

Pin number	Port name	Description
1-3	T1-T3	Output tunable band pass filter control signals.
4	T4	Output port for tunable band pass filter control signal while receiving. output power control signal while transmitting.

4-5-3 CPU (MAIN unit; IC20)

Pin number	Port name	Description
1	DSDA	I/O port for data signals from/to the D/A converter (IC7).
2	DAST	Outputs strobe signals for the level controller (or D/A converter) (IC6).
8, 9	LINH, LCS	Output ports for LCD control signals to the LCD driver (FRONT unit; IC1)
10	LCK	Outputs clock signal for the LCD driver (FRONT unit; IC1)
11	LSO	Outputs data signals for the LCD driver (FRONT unit; IC1)
13	PLST	Outputs strobe signals for the PLL IC (IC4).
16	TXC	Outputs R8 regulator circuit (Q26, Q30, D24) control signal.
17	TMUT	Outputs T8 regulator circuit (Q25, Q29, D23) control signal.
18	AFON	Outputs control signal for the AF regulator circuit (Q39, Q40, D31). High : While AF amplifier (IC8) is activated.
19	NWC	Outputs IF bandwidth control signal. High : While IF bandwidth is narrow.
20	DDSD	Input port for the data signals from the DTMF decoder (IC19).
21	DDAC	Outputs clock signal to the DTMF decoder (IC19).
22	SO	Outputs data signals to the PLL IC (IC4), level controller (or D/A converter) (IC6), compander IC (IC14) and optional board (connect to J1).
23	SI	Input port for the clock signal from the optional board via J1.
24	SCK	Outputs clock signal to the PLL IC (IC4), level controller (or D/A converter) (IC6), D/A converter (IC7), compander IC (IC14) and optional board (connect to J1).
25	CCS	Outputs chip select signal for the optional board via J1.
26-28	KR2-KR0	Input ports for the key matrix.
29	PTTO	Input port for the PTT switch from the optional board via J1. Low : External PTT switch is ON.
30	HANG	Input port for the microphone hanger detection signal. Low : Microphone on hook
31	BUSY	Outputs BUSY detection signal for the optional board via J1.
32	RMUT	Input port for AF mute signal from the optional board via J1.

CPU (IC20)—continued

Pin number	Port name	Description
33	MMUT	Input port for MIC mute signal from the optional board via J1.
34–36	OPT1–OPT3	I/O ports for the optional board control signals.
37	NOIS	NOIS signal input port from the FM IF IC (MAIN unit; IC1) for noise squelch operation.
38	POSW	Input for the POWER switch. Low : While POWER switch is pushed.
39	DDST	Input port for DTMF detection signal from the DTMF decoder (IC19).
40	IGSW	Remote power control signal input port from the external connector (J8).
41	PWON	Outputs control signal for the power switching circuit (Q24, Q23) via D28.
43	SENC	Outputs single tone signal.
44	BEEP	Outputs beep audio signals.
45	SDEC	Single tone signal input port for decoding from the LPF (IC21c).
46	CDEC	CTCSS/DTCS signals input port for decoding from the LPF (IC5).
47	ULCK	Input port for the PLL unlock signal from the PLL IC (IC4).
48	BATV	Input port for the overvoltage detection from the connected power supply.
49	LVIN	Input port for the PLL lock voltage.
50	RSSI	Input port for receiving signal strength level detection.
51	TEMP	Input port for the transceiver's internal temperature.
52	AFVI	Input port for the AF volume control (FRONT unit; R12). High : [VOL] is maximum clockwise.
55	EPTT	Input port for the PTT switch from the external connector (J6). Low : External PTT switch is ON.
59	RES	Input port for the reset signal.
68	CLO	Output port for the cloning signal.
69	CLI	Input port for the cloning signal.
70	CSFT	Outputs CPU clock shift signal.
71	DUSE	Outputs cut-off frequency control signal to the low-pass filter (IC5) for CTCSS/DTCS switching.
74	XCTS	Input port for the connected modem unit via external connector (J9).
75	XRTS	Output port for the connected modem unit via external connector (J9).

CPU (IC20)—continued

Pin number	Port name	Description
76	XTXD	Input port for serial data signals from the connected MAP27 unit via external connector (J9).
77	XRXD	Outputs serial data signals for the connected MAP27 unit via external connector (J9).
79	NTXD	Output serial data signals (data format is in accordance with NMEA0183) for the connected unit via external connector (J8).
80	NRXD	Input port for serial data signals (data format is in accordance with NMEA0183) from the connected unit via external connector (J8).
81	CIRQ	Input port for interruption signal from the optional board via J1
88	DIM	Input port for the LCD backlight control signal from the external connector (J6).
89–91	CENC2–CENC0	Output ports for the CTCSS/ DTCS signals.
92	AFCL	Outputs reset signal for the compander IC (IC14).
94, 95	AMSK, ADIN	Output control signals for the compander IC (IC14).
96	APST	Outputs strobe signals to the compander IC (IC14).
97	PMFM	Outputs control signal for the MSK PM/FM switching circuit (IC15).
98	ESDA	I/O port for the data signals from the EEPROM (IC23).
99	ESCL	Outputs clock signal for the EEPROM (IC23).
100	PA	Outputs MIC audio select signal for the analog switch (IC25). Low : While "Public-address" function is ON.

SECTION 5 ADJUSTMENT PROCEDURES

Note: [MPT] versions must use 'CS-F600' instead of 'CS-F500'.

5-1 PREPARATION

When you adjust the contents on pages 5-4 and 5-5, SOFTWARE ADJUSTMENT, the optional CS-F500 ADJ ADJUSTMENT SOFTWARE (Rev. 1.0 or later), *OPC-1122 JIG CABLE (modified OPC-1122 CLONING CABLE; see illustration below) are required.

SYSTEM REQUIREMENTS

- IBM PC compatible computer with an RS -232C serial port (38400 bps or faster)
- Microsoft Windows 95/98 or Windows ME
- Intel Pentium 100 MHz processor or faster
- At least 16 MB RAM and 10 MB of hard disk space
- 640x480 pixel display (800x600 pixel display recommended)

IBM is a registered trademark of International Bussiness Machines Corporation in the U.S.A. and other countries. Microsoft and Windows are registered trademarks of Microsoft Corporation in the U.S.A. and other countries. Screen shots produced with permission from Microsoft Corporation. All other products or brands are registered trademarks or trademarks of their respective holders.

ADJUSTMENT SOFTWARE INSTALLATION

- ① Boot up Windows.
 - Quit all applications when Windows is running.
- ② Insert the 'CS-F500' into the appropriate CD-ROM drive.
- ③ Select 'Run' from the [Start] menu.
- ④ Type the setup program name using the full path name, then push [Enter] key.
(ex. D:\CSF500ADJ\disk1\Setup.exe)
- ⑤ Follow the prompts.
- ⑥ Program group 'CS-F500 ADJ' appears in the 'Programs' folder of the [Start] menu.

STARTING SOFTWARE ADJUSTMENT

- ① Connect IC-F610, F620 or F621 and PC with *OPC-1122 JIG CABLE.
- ② Turn the transceiver power ON.
- ③ Boot up Windows, and click the program group 'CS-F500 ADJ' in the 'Programs' folder of the [Start] menu, then CS-F500 ADJ's window appears.
- ④ Click 'Connect' on the CS-F500's window, then appears IC-F610, F620 or F621's up-to-date condition.
- ⑤ Set or modify adjustment data as desired.

*OPC-1122 (JIG CABLE)

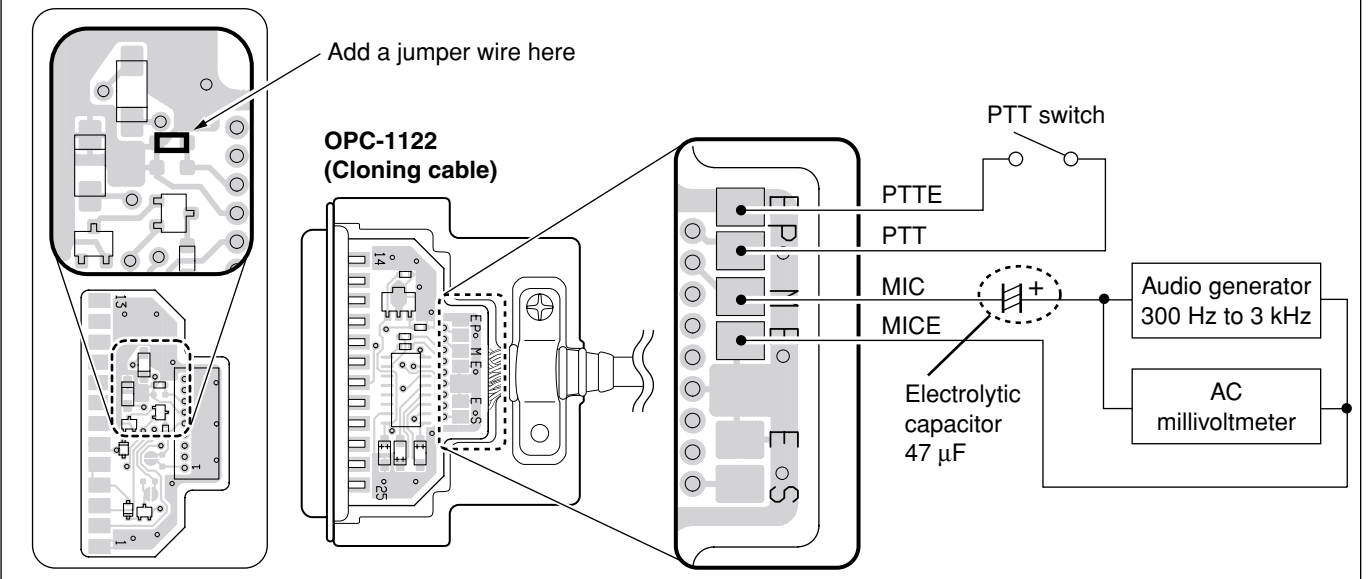

REQUIRED TEST EQUIPMENT

EQUIPMENT	GRADE AND RANGE	EQUIPMENT	GRADE AND RANGE
DC power supply	Output voltage : 13.2 (13.6) V DC Current capacity : 20 A or more	Audio generator	Frequency range : 300-3000 Hz Measuring range : 1-500 mV
RF power meter (terminated type)	Measuring range : 1-75 W Frequency range : 300-600 MHz Impedance : 50 Ω SWR : Less than 1.2 : 1	Standard signal generator (SSG)	Frequency range : 0.1-600 MHz Output level : 0.1 µV-32 mV (-127 to -17 dBm)
Frequency counter	Frequency range : 0.1-600 MHz Frequency accuracy : ±1 ppm or better Sensitivity : 100 mV or better	Oscilloscope	Frequency range : DC-20 MHz Measuring range : 0.01-20 V
FM deviation meter	Frequency range : DC-600 MHz Measuring range : 0 to ±10 kHz	AC millivoltmeter	Measuring range : 10 mV-10 V
DC voltmeter	Input impedance : 50 kΩ/V DC or better	External speaker	Input impedance : 4 Ω Capacity : 7 W or more
		Attenuator	Power attenuation : 50 or 60 dB Capacity : 100 W or more

• Screen display example

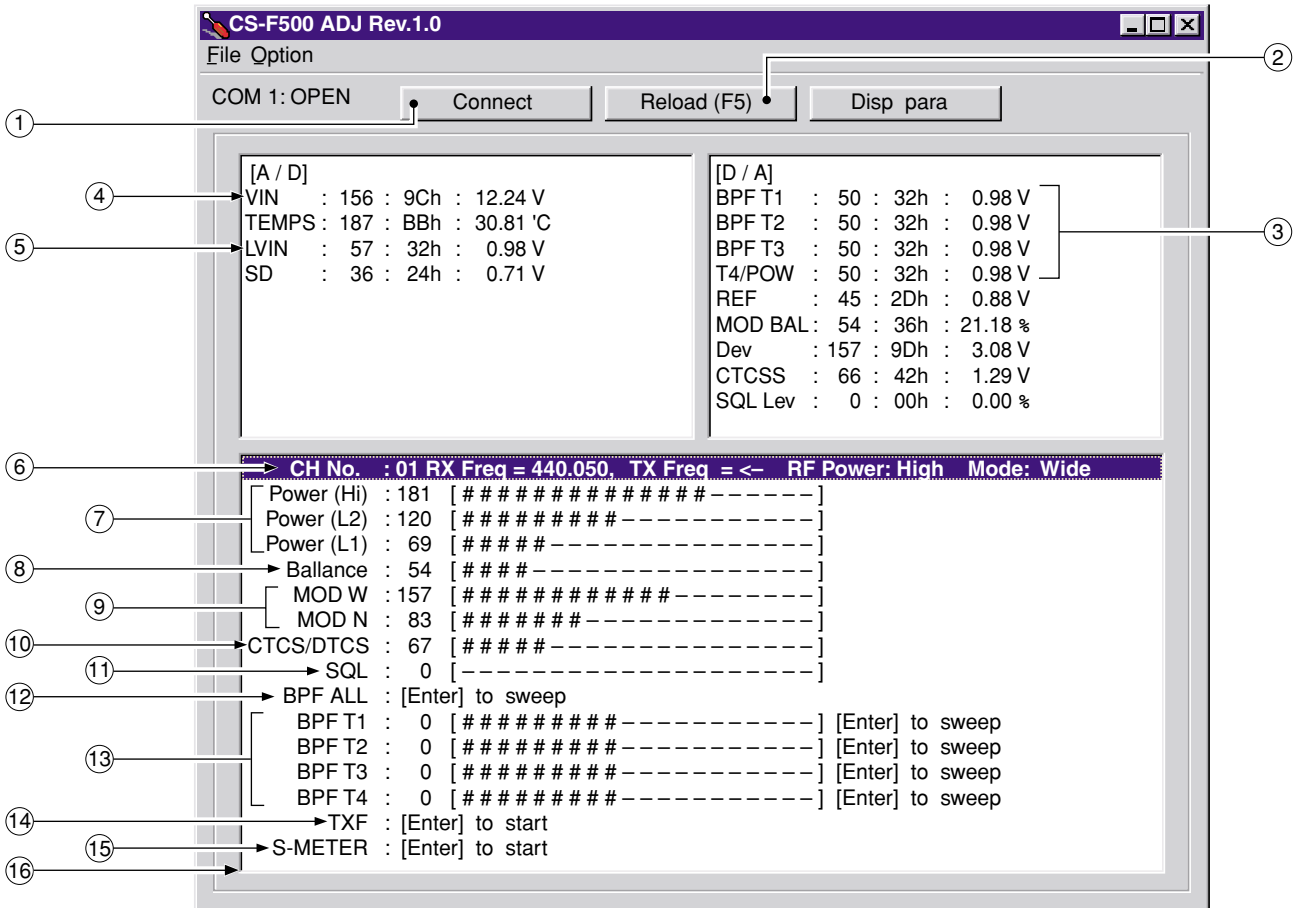

NOTE: The above values for settings are example only.
Each transceiver has its own specific values for each setting.

- | | | | |
|-------------------------------------|------------------------------|---|--------------------------------------|
| ① : Transceiver's connection state | ⑤ : PLL lock voltage | ⑨ : FM deviation | ⑬ : Receive sensitivity (manually) |
| ② : Reload adjustment data | ⑥ : Operating channel select | ⑩ : CTCSS/DTCS deviation | ⑭ : Reference frequency |
| ③ : Receive sensitivity measurement | ⑦ : RF output power | ⑪ : Squelch level | ⑮ : S-meter |
| ④ : Connected DC voltage | ⑧ : Modulation balance | ⑫ : Receive sensitivity (automatically) | ⑯ : Adjustment items (automatically) |

• Connections

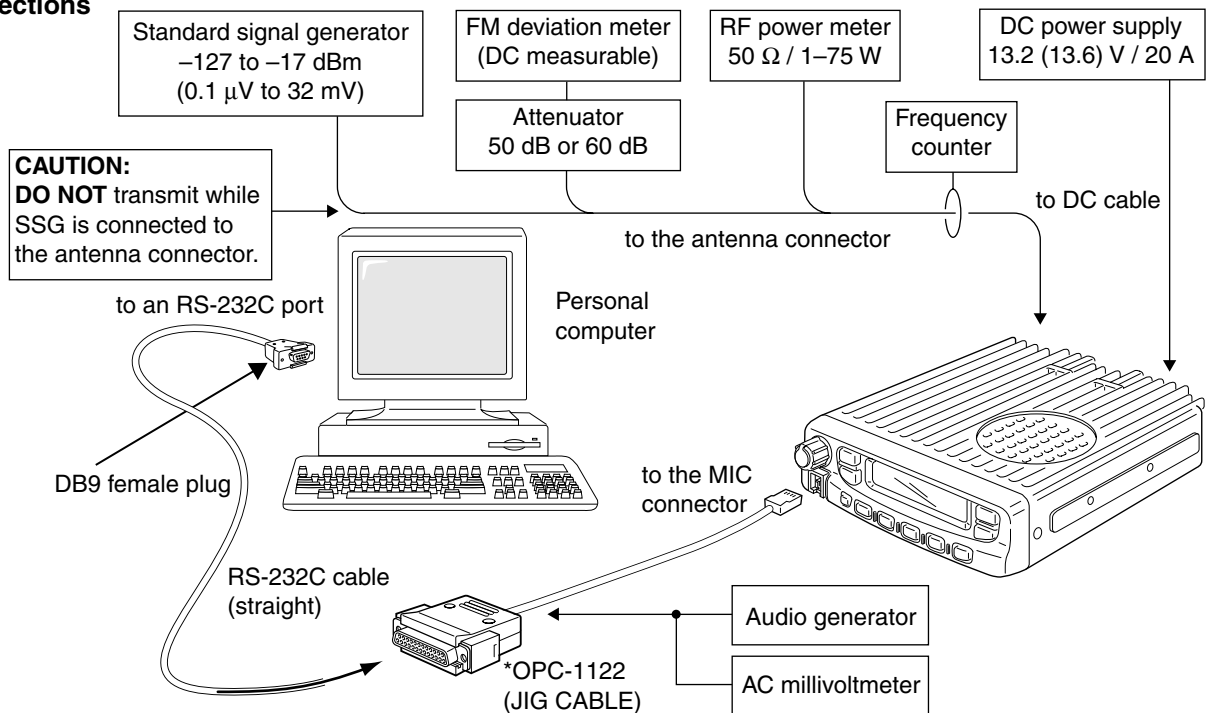

5-2 PLL ADJUSTMENT

ADJUSTMENT	ADJUSTMENT CONDITIONS	MEASUREMENT		VALUE	ADJUSTMENT	
		UNIT	LOCATION		UNIT	ADJUST
PLL LOCK VOLTAGE	1 • Operating freq. : 400.000 MHz [L] 440.000 MHz [M] 480.000 MHz [H] • Receiving	MAIN	Connect a digital multi-meter or an oscilloscope to the check point, "LV".	1.0 V	MAIN	C133
	2 • Output power : Low1 • Transmitting					
	3 • Operating freq. : 430.000 MHz [L] 490.000 MHz [M] 520.000 MHz [H] • Receiving			3.0-4.2 V [L] 3.3-4.5 V [M] 3.3-4.5 V [H]		Verify
	4 • Output power : Low1 • Transmitting					

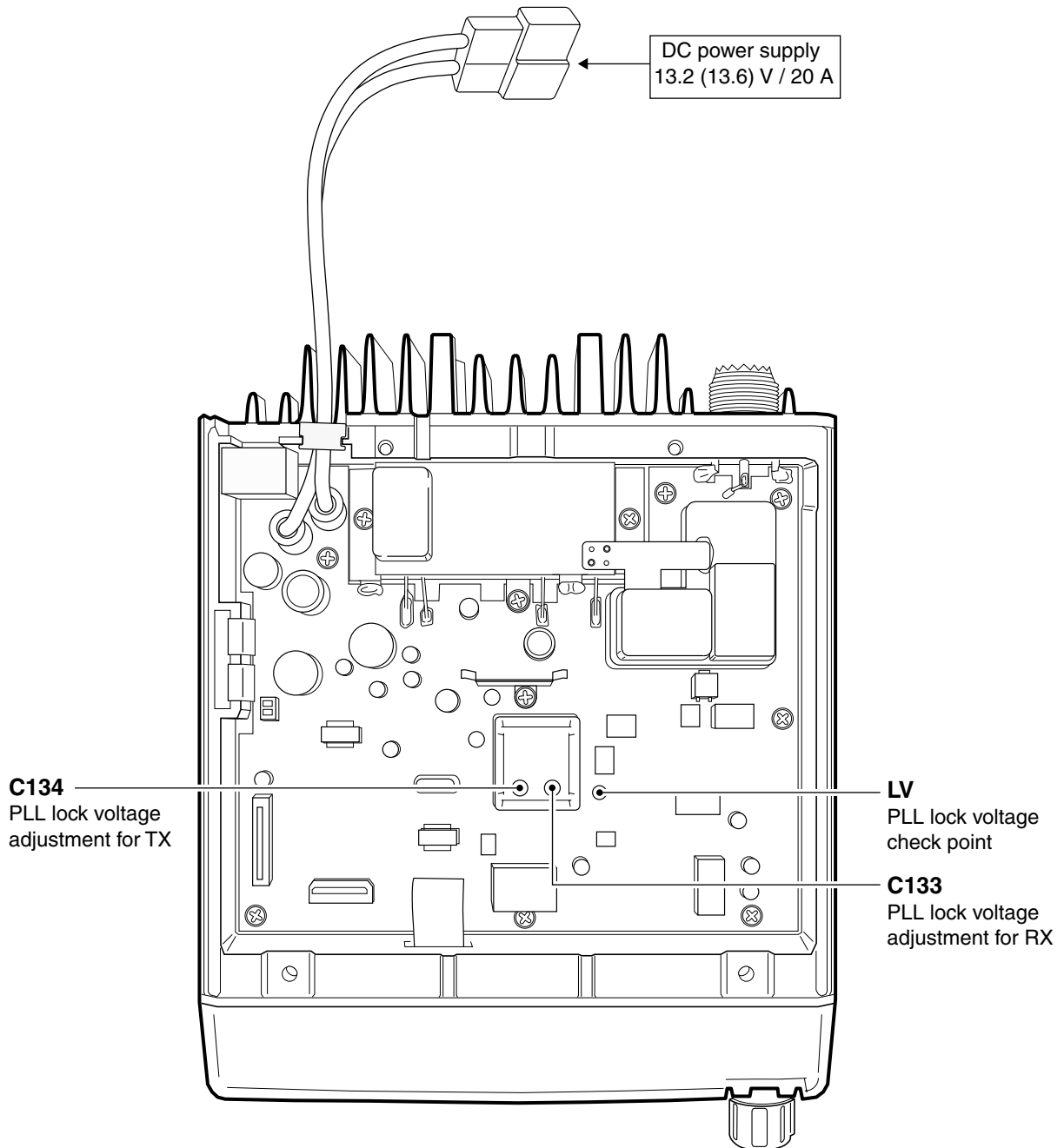

5-3 SOFTWARE ADJUSTMENT

Select an operation using [↑] / [↓] keys, then set specified value using [←] / [→] keys on the connected computer keyboard.

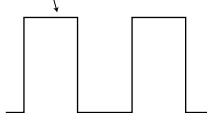
ADJUSTMENT	ADJUSTMENT CONDITION	MEASUREMENT		VALUE
		UNIT	LOCATION	
REFERENCE FREQUENCY [TXF]	1 <ul style="list-style-type: none"> Operating freq. : 430.000 MHz [L] 490.000 MHz [M] 520.000 MHz [H] Output power : Low1 Connect the RF power meter or 50 Ω dummy load to the antenna connector. Transmitting 	Rear panel	Loosely couple a frequency counter to the antenna connector.	430.0000 MHz [L] 490.0000 MHz [M] 520.0000 MHz [H]
OUTPUT POWER [Power (Hi)]	1 <ul style="list-style-type: none"> Operating freq. : 400.000 MHz [L] 440.000 MHz [M] 480.000 MHz [H] Output power : High Transmitting 	Rear panel	Connect an RF power meter to the antenna connector.	25.0 W [25W] 45.0 W [45W]
[Power (L2)]	2 <ul style="list-style-type: none"> Output power : Low2 Transmitting 			10.0 W [25W] 25.0 W [45W]
[Power (L1)]	3 <ul style="list-style-type: none"> Output power : Low1 Transmitting 			2.5 W [25W] 4.5 W [45W]
MODULATION BALLANCE [Ballance]	1 <ul style="list-style-type: none"> Operating freq. : 415.000 MHz [L] 465.000 MHz [M] 500.000 MHz [H] Output power : Low1 Push [P0] key while transmitting 	Rear panel	Connect an FM deviation meter with an oscilloscope to the antenna connector through an attenuator.	Set to square wave form 
FM DEVIATION [MOD W]	1 <ul style="list-style-type: none"> Operating freq. : 415.000 MHz [L] 465.000 MHz [M] 500.000 MHz [H] Output power : Low1 IF bandwidth : Wide Connect an audio generator to the [MIC] jack through the JIG cable and set as: 1.0 kHz/40 mVrms Set an FM deviation meter as: HPF : OFF LPF : 20 kHz De-emphasis: OFF Detector : (P-P)/2 Transmitting 	Rear panel	Connect an FM deviation meter to the antenna connector through the attenuator.	±4.1 kHz [N/W] ±3.3 kHz [N/M]
[MOD N]	2 <ul style="list-style-type: none"> IF bandwidth : Narrow Transmitting 			±2.1 kHz
CTCSS/DTCS DEVIATION [CTCS/DTCS]	<ul style="list-style-type: none"> Operating freq. : 415.000 MHz [L] 465.000 MHz [M] 500.000 MHz [H] Output power : Low1 IF bandwidth : Wide CTCSS : 88.5 Hz DTCS code : 007 Set the FM deviation meter as: HPF : OFF LPF : 20 kHz De-emphasis: OFF Detector : (P-P)/2 No audio applied to the [MIC] connector. Transmitting 	Rear panel	Connect an FM deviation meter to the antenna connector through the attenuator.	±0.70 kHz [N/W] ±0.56 kHz [N/M]

SOFTWARE ADJUSTMENT – continued

Select an operation using [↑] / [↓] keys, then set specified value using [←] / [→] keys on the connected computer keyboard.

ADJUSTMENT	ADJUSTMENT CONDITION	MEASUREMENT		VALUE	
		UNIT	LOCATION		
RX SENSITIVITY [BPF T1] – [BPF T4]	1	<ul style="list-style-type: none"> Operating freq. : 400.000 MHz [L] 440.000 MHz [M] 480.000 MHz [H] IF bandwidth : Wide Connect a standard signal generator to the antenna connector and set as: Frequency : 400.000 MHz [L] 440.000 MHz [M] 480.000 MHz [H] Level : 10 μV* (–87 dBm) Modulation : 1 kHz Deviation : ±3.5 kHz [N/W] ±2.8 kHz [N/M] Receiving 	MAIN	Connect a SINAD meter with a 4 Ω load to the external [SP] jack.	Minimum distortion level
	<p>CONVENIENT: The BPF T1–BPF T4 can be adjusted automatically.</p> <p>①-1: Set the cursor to “BPF ALL” on the adjustment program and then push [ENTER] key. ①-2: The connected PC tunes BPF T1–BPF T4 to peak levels. or ②-1: Set the cursor to one of BPF T1, T2, T3, or T4 as desired. ②-2: Push [ENTER] key to start tuning. ②-3: Repeat ②-1 and ②-2 to perform additional BPF tuning.</p>				
S-METER [S-METER]	1	<ul style="list-style-type: none"> Operating freq. : 400.000 MHz [L] 440.000 MHz [M] 480.000 MHz [H] IF bandwidth : Wide Connect an SSG to the antenna connector and set as: Frequency : 400.000 MHz [L] 440.000 MHz [M] 480.000 MHz [H] Level : 14 μV* (–84 dBm) Modulation : 1 kHz Deviation : ±3.5 kHz [N/W] ±2.8 kHz [N/M] Receiving 			Push [ENTER] key on the connected computer keyboard to set “S3 level”.
	2	<ul style="list-style-type: none"> Set an SSG as : Level : 0.45 μV* (–114 dBm) Modulation : 1 kHz Deviation : ±3.5 kHz [N/W] ±2.8 kHz [N/M] Receiving 			Push [ENTER] key on the connected computer keyboard to set “S1 level”.
SQUELCH LEVEL [SQL]	1	<ul style="list-style-type: none"> Operating freq. : 415.000 MHz [L] 465.000 MHz [M] 500.000 MHz [H] IF bandwidth : Narrow Connect an SSG to the antenna connector and set as: Frequency : 415.000 MHz [L] 465.000 MHz [M] 500.000 MHz [H] Level : 0.2 μV* (–121 dBm) Modulation : 1 kHz Deviation : ±1.75 kHz Receiving 	Rear panel	Connect a SINAD meter with a 4 Ω load to the external [SP] jack.	Set “SQL level” to close squelch. Then set “SQL level” at the point where the audio signals just appears.

*The output level of the standard signal generator (SSG) is indicated as the SSG’s open circuit.

SECTION 6 PARTS LIST

[FRONT UNIT]

REF NO.	ORDER NO.	DESCRIPTION	
IC1	1130010800	S.IC	LC75824W
IC2	1130008560	S.IC	TC75S51F (TE85L)
Q1	1590000720	S.TRANSISTOR	DTA144EUA T106
Q2	1590000430	S.TRANSISTOR	DTC144EUA T106
Q3	1590000430	S.TRANSISTOR	DTC144EUA T106
Q4	1590000720	S.TRANSISTOR	DTA144EUA T106
D1	1790001670	S.DIODE	RB706F-40T106
D2	1790001670	S.DIODE	RB706F-40T106
D3	1790001670	S.DIODE	RB706F-40T106
D4	1790001250	S.DIODE	MA2S111-(TX)
D5	1790001250	S.DIODE	MA2S111-(TX)
D6	1790001250	S.DIODE	MA2S111-(TX)
L1	6200003960	S.COIL	MLF1608A 1R0K-T
R1	7030003440	S.RESISTOR	ERJ3GEYJ 102 V (1 kΩ)
R2	7030003440	S.RESISTOR	ERJ3GEYJ 102 V (1 kΩ)
R3	7030003390	S.RESISTOR	ERJ3GEYJ 391 V (390 Ω)
R4	7030003390	S.RESISTOR	ERJ3GEYJ 391 V (390 Ω)
R5	7030003520	S.RESISTOR	ERJ3GEYJ 472 V (4.7 kΩ)
R6	7030003440	S.RESISTOR	ERJ3GEYJ 102 V (1 kΩ)
R7	7030000330	S.RESISTOR	MCR10EZHZ 390 Ω (391)
R8	7410000950	S.ARRAY	EXB-V8V 102JV
R9	7410000770	S.ARRAY	EXB-V4V 102JV (1 kΩ)
R10	7030003680	S.RESISTOR	ERJ3GEYJ 104 V (100 kΩ)
R11	7030003680	S.RESISTOR	ERJ3GEYJ 104 V (100 kΩ)
R12	7210003020	VARIABLE	EVU-F2KFK1 B14 (10KB)
R13	7030003730	S.RESISTOR	ERJ3GEYJ 274 V (270 kΩ)
R14	7030003680	S.RESISTOR	ERJ3GEYJ 104 V (100 kΩ)
R16	7030003440	S.RESISTOR	ERJ3GEYJ 102 V (1 kΩ)
R17	7030003560	S.RESISTOR	ERJ3GEYJ 103 V (10 kΩ)
R18	7030003560	S.RESISTOR	ERJ3GEYJ 103 V (10 kΩ)
R19	7030003560	S.RESISTOR	ERJ3GEYJ 103 V (10 kΩ)
R20	7030003510	S.RESISTOR	ERJ3GEYJ 392 V (3.9 kΩ)
R21	7030003800	S.RESISTOR	ERJ3GEYJ 105 V (1 MΩ)
R22	7030003560	S.RESISTOR	ERJ3GEYJ 103 V (10 kΩ)
R23	7030003560	S.RESISTOR	ERJ3GEYJ 103 V (10 kΩ)
R24	7030003480	S.RESISTOR	ERJ3GEYJ 222 V (2.2 kΩ)
R25	7030003640	S.RESISTOR	ERJ3GEYJ 473 V (47 kΩ)
C1	4030007090	S.CERAMIC	C1608 CH 1H 470J-T
C2	4030007090	S.CERAMIC	C1608 CH 1H 470J-T
C3	4030007090	S.CERAMIC	C1608 CH 1H 470J-T
C4	4030007090	S.CERAMIC	C1608 CH 1H 470J-T
C5	4030007090	S.CERAMIC	C1608 CH 1H 470J-T
C6	4030007090	S.CERAMIC	C1608 CH 1H 470J-T
C7	4030007090	S.CERAMIC	C1608 CH 1H 470J-T
C8	4030007090	S.CERAMIC	C1608 CH 1H 470J-T
C9	4030007090	S.CERAMIC	C1608 CH 1H 470J-T
C10	4030007090	S.CERAMIC	C1608 CH 1H 470J-T
C11	4030007090	S.CERAMIC	C1608 CH 1H 470J-T
C12	4030007090	S.CERAMIC	C1608 CH 1H 470J-T
C13	4030007090	S.CERAMIC	C1608 CH 1H 470J-T
C14	4030007090	S.CERAMIC	C1608 CH 1H 470J-T
C15	4030007090	S.CERAMIC	C1608 CH 1H 470J-T
C16	4030007090	S.CERAMIC	C1608 CH 1H 470J-T
C17	4030007090	S.CERAMIC	C1608 CH 1H 470J-T
C18	4030007090	S.CERAMIC	C1608 CH 1H 470J-T
C19	4030006860	S.CERAMIC	C1608 JB 1H 102K-T
C20	4030006860	S.CERAMIC	C1608 JB 1H 102K-T
C21	4030007090	S.CERAMIC	C1608 CH 1H 470J-T
C22	4030007090	S.CERAMIC	C1608 CH 1H 470J-T
C23	4030007090	S.CERAMIC	C1608 CH 1H 470J-T
C24	4030007090	S.CERAMIC	C1608 CH 1H 470J-T
C25	4030007090	S.CERAMIC	C1608 CH 1H 470J-T
C26	4030007090	S.CERAMIC	C1608 CH 1H 470J-T
C27	4030007090	S.CERAMIC	C1608 CH 1H 470J-T
C28	4030007090	S.CERAMIC	C1608 CH 1H 470J-T
C29	4030007090	S.CERAMIC	C1608 CH 1H 470J-T

[FRONT UNIT]

REF NO.	ORDER NO.	DESCRIPTION	
C30	4030011600	S.CERAMIC	C1608 JB 1E 104K-T
C31	4030011600	S.CERAMIC	C1608 JB 1E 104K-T
C32	4030011600	S.CERAMIC	C1608 JB 1E 104K-T
C33	4030007130	S.CERAMIC	C1608 CH 1H 101J-T
C34	4030007090	S.CERAMIC	C1608 CH 1H 470J-T
C35	4030007090	S.CERAMIC	C1608 CH 1H 470J-T
C37	4550000550	S.TANTALUM	TESVA 1V 224M1-8L
C39	4030006900	S.CERAMIC	C1608 JB 1H 103K-T
C40	4550005980	S.TANTALUM	TEMSVA 1A 475M-8L
C41	4030006860	S.CERAMIC	C1608 JB 1H 102K-T
J1	6450002210	CONNECTOR	3017-8821
J2	6510023090	S.CONNECTOR	20FLT-SM1-TB
DS1	5040002310	S.LED	SML-311YTT86
DS2	5040002310	S.LED	SML-311YTT86
DS3	5040002310	S.LED	SML-311YTT86
DS4	5040002310	S.LED	SML-311YTT86
DS5	5040002310	S.LED	SML-311YTT86
DS6	5040002310	S.LED	SML-311YTT86
DS7	5040002310	S.LED	SML-311YTT86
DS8	5040002310	S.LED	SML-311YTT86
DS9	5040002310	S.LED	SML-311YTT86
DS10	5040002310	S.LED	SML-311YTT86
DS11	5040002310	S.LED	SML-311YTT86
DS12	5030002230	LCD	L1-0483TAT
W1	8900010950	CABLE	OPC-1126 (P=0.5 N=20 L=90)
EP1	0910054932	PCB	B 5809B
EP2	8930057820	LCD CONTACT	SRCN-2526-SP-N-W

S.=Surface mount

[MAIN UNIT]

REF NO.	ORDER NO.	DESCRIPTION	
IC1	1110003490	S.IC	TA31136FN (D, EL)
IC2	1130008560	S.IC	TC75S51F (TE85L)
IC3	1150002090	IC	RA30H4047M-01 [L]
	1150002030	IC	RA30H4452M [M]-25W, [H]
	1150002060	IC	RA45H4452M [M]-45W
IC4	1130010810	S.IC	SA7026DH-T
IC5	1110005330	S.IC	NJM12904V-TE1
IC6	1190001350	S.IC	M62364FP 600D
IC7	1190001340	S.IC	M62334FP 600C
IC8	1110003090	IC	LA4425A
IC9	1180001250	S.IC	TA7808F (TE16L)
IC10	1180000970	S.IC	AN78L05M-(E1)
IC11	1130008560	S.IC	TC75S51F (TE85L)
IC14	1130009330	S.IC	TC35453F (BR, DRY)
IC15	1130006220	S.IC	TC4W53FU (TE12L)
IC18	1110002750	S.IC	TA75S01F (TE85R)
IC19	1130009700	S.IC	LC73872M-TRM
IC20	1140010190	S.IC	HD64F2268TF (EMPTY)
IC21	1110005340	S.IC	NJM12902V-TE1
IC22	1130004200	S.IC	TC4S66F (TE85R)
IC23	1140009240	S.IC	HN58X24128FPI
IC24	1130009110	S.IC	S-80942ANMP-DD6-T2
IC25	1130004200	S.IC	TC4S66F (TE85R)
Q1	1560000840	S.FET	2SK1829 (TE85R)
Q2	1580000730	S.FET	3SK293 (TE85L)
Q3	1580000660	S.FET	3SK272-(TX)
Q4	1530002600	S.TRANSISTOR	2SC4215-O (TE85R)
Q5	1530002850	S.TRANSISTOR	2SC4116-BL (TE85R)
Q6	1590000720	S.TRANSISTOR	DTA144EUA T106
Q8	1530000372	S.TRANSISTOR	2SC3356 R24-T1B
Q9	1530003310	S.TRANSISTOR	2SC5107-O (TE85R)
Q10	1530003310	S.TRANSISTOR	2SC5107-O (TE85R)
Q11	1530003310	S.TRANSISTOR	2SC5107-O (TE85R)
Q12	1530003310	S.TRANSISTOR	2SC5107-O (TE85R)
Q13	1530002920	S.TRANSISTOR	2SC4226-T1 R25
Q14	1530002920	S.TRANSISTOR	2SC4226-T1 R25
Q15	1590001400	S.TRANSISTOR	XP1214 (TX)
Q16	1590000430	S.TRANSISTOR	DTC144EUA T106
Q17	1530002850	S.TRANSISTOR	2SC4116-BL (TE85R)
Q18	1560000540	S.FET	2SK880-Y (TE85R)
Q19	1530002600	S.TRANSISTOR	2SC4215-O (TE85R)
Q20	1530003090	S.TRANSISTOR	2SC4213-B (TE85R)
Q21	1530002850	S.TRANSISTOR	2SC4116-BL (TE85R)
Q22	1590000430	S.TRANSISTOR	DTC144EUA T106
Q23	1550000020	S.FET	2SJ377 (TE16R)
Q24	1590000430	S.TRANSISTOR	DTC144EUA T106
Q25	1540000550	S.TRANSISTOR	2SD1664 T100Q
Q26	1540000550	S.TRANSISTOR	2SD1664 T100Q
Q27	1520000460	S.TRANSISTOR	2SB1132 T100 R
Q28	1590001190	S.TRANSISTOR	XP6501-(TX).AB
Q29	1590000430	S.TRANSISTOR	DTC144EUA T106
Q30	1590000430	S.TRANSISTOR	DTC144EUA T106
Q31	1590001450	S.FET	2SJ144-GR (TE85R)
Q32	1590000430	S.TRANSISTOR	DTC144EUA T106
Q33	1590000430	S.TRANSISTOR	DTC144EUA T106
Q34	1530002850	S.TRANSISTOR	2SC4116-BL (TE85R)
Q35	1590001400	S.TRANSISTOR	XP1214 (TX)
Q36	1530002850	S.TRANSISTOR	2SC4116-BL (TE85R)
Q37	1530002850	S.TRANSISTOR	2SC4116-BL (TE85R)
Q38	1590000430	S.TRANSISTOR	DTC144EUA T106
Q39	1590000990	S.TRANSISTOR	DTC363EK T146
Q40	1590000430	S.TRANSISTOR	DTC144EUA T106
Q41	1590000720	S.TRANSISTOR	DTA144EUA T106
Q42	1590000430	S.TRANSISTOR	DTC144EUA T106
Q43	1590000430	S.TRANSISTOR	DTC144EUA T106
Q44	1590000430	S.TRANSISTOR	DTC144EUA T106
Q48	1590000430	S.TRANSISTOR	DTC144EUA T106
Q49	1590000430	S.TRANSISTOR	DTC144EUA T106
Q50	1590000430	S.TRANSISTOR	DTC144EUA T106
Q51	1530002850	S.TRANSISTOR	2SC4116-BL (TE85R) [45W]
D1	1790000660	S.DIODE	MA728 (TX)
D2	1750000510	S.DIODE	UM9401F [25W]
D3	1710001060	DIODE	XB15A407 [45W]
D4	1750000710	S.VARICAP	HVC350BTRF
D5	1750000760	S.DIODE	MA4PH224
D6	1790000620	S.DIODE	MA77 (TX)
D8	1750000710	S.VARICAP	HVC350BTRF
D9	1750000710	S.VARICAP	HVC350BTRF

[MAIN UNIT]

REF NO.	ORDER NO.	DESCRIPTION	
D10	1750000710	S.VARICAP	HVC350BTRF
D11	1790000660	S.DIODE	MA728 (TX)
D14	1790000620	S.DIODE	MA77 (TX)
D15	1790000620	S.DIODE	MA77 (TX)
D16	1750000710	S.VARICAP	HVC350BTRF
D17	1750000710	S.VARICAP	HVC350BTRF
D18	1720000570	S.VARICAP	MA368 (TX)
D19	1790001250	S.DIODE	MA2S111-(TX)
D20	1790001250	S.DIODE	MA2S111-(TX)
D21	1750000830	S.VARICAP	HVC362TRF
D22	1790000700	DIODE	DSA3A1
D23	1750000370	S.DIODE	DA221 3L
D24	1750000370	S.DIODE	DA221 TL
D25	1790001250	S.DIODE	MA2S111-(TX)
D26	1790001250	S.DIODE	MA2S111-(TX)
D27	1790000620	S.DIODE	MA77 (TX)
D28	1750000520	S.DIODE	DAN222TL
D30	1790001250	S.DIODE	MA2S111-(TX)
D31	1750000520	S.DIODE	DAN222TL
D32	1790001250	S.DIODE	MA2S111-(TX)
D33	1790001250	S.DIODE	MA2S111-(TX)
D34	1790001250	S.DIODE	MA2S111-(TX)
D35	1750000520	S.DIODE	DAN222TL
D36	1750000520	S.DIODE	DAN222TL
D37	1750000520	S.DIODE	DAN222TL
FI1	2010002450	S.XTAL	FL-313 (46.35 MHz) [USA], [GEN]
	2030000150	S.MONOLITH	FL-335 (46.350 MHz) [EUR]
FI2	2020001840	CERAMIC	ALFYM450F=K
FI3	2040001440	S.LC	NFE31PT152Z1E9L
FI4	2040001440	S.LC	NFE31PT152Z1E9L
FI5	2040001440	S.LC	NFE31PT152Z1E9L [45W]
X1	6070000190	S.DISCRIMINATOR	CDBC450KCAV24-R0
X2	6050011120	S.XTAL	CR-671A (15.300 MHz)
X3	6050009910	S.XTAL	CR-563 (3.579545 MHz)
X4	6050009520	S.XTAL	CR-520 (19.6608 MHz+)
L1	6110001520	COIL	LA-232 [25W]
	6110002110	COIL	LA-382 [45W]
L2	6110001520	COIL	LA-232
L3	6110002110	COIL	LA-382
L4	6200008330	S.COIL	0.45-1.4-4TL 15N
L5	6170000230	COIL	LW-25
L6	6200008330	S.COIL	0.45-1.4-4TL 15N
L7	6200007230	S.COIL	LQW2BHN15NJ01L [L]
	6200007670	S.COIL	LQW2BHN10NJ01L [M], [H]
L8	6200007680	S.COIL	LQW2BHN12NJ01L [L]
	6200007670	S.COIL	LQW2BHN10NJ01L [M], [H]
L9	6200007680	S.COIL	LQW2BHN12NJ01L [L]
	6200007670	S.COIL	LQW2BHN10NJ01L [M], [H]
L11	6200007680	S.COIL	LQW2BHN12NJ01L [L]
	6200007670	S.COIL	LQW2BHN10NJ01L [M], [H]
L12	6200005720	S.COIL	ELJRE 33NG-F
L13	6200003350	S.COIL	ELJNC R27K-F
L16	6110001520	COIL	LA-232 [25W]
	6110002110	COIL	LA-382 [45W]
L18	6200005690	S.COIL	ELJRE 18NG-F [L]
	6200005680	S.COIL	ELJRE 15NG-F [M], [H]
L19	6200005690	S.COIL	ELJRE 18NG-F [L]
	6200005680	S.COIL	ELJRE 15NG-F [M], [H]
L20	6200005710	S.COIL	ELJRE 27NG-F [L]
	6200005700	S.COIL	ELJRE 22NG-F [M], [H]
L21	6200005710	S.COIL	ELJRE 27NG-F [L]
	6200005700	S.COIL	ELJRE 22NG-F [M], [H]
L22	6200005710	S.COIL	ELJRE 27NG-F
L23	6200004950	S.COIL	NL 252018T-1R8J
L24	6200004950	S.COIL	NL 252018T-1R8J
L25	6200009360	S.COIL	0.45-1.4-3TL 11N
L26	6200009360	S.COIL	0.45-1.4-3TL 11N
L27	6200004950	S.COIL	NL 252018T-1R8J
L28	6200004950	S.COIL	NL 252018T-1R8J
L29	6200004950	S.COIL	NL 252018T-1R8J
L31	6200007740	S.COIL	LQW2BHN47NJ01L
L32	6200005690	S.COIL	ELJRE 18NG-F [L]
	6200005680	S.COIL	ELJRE 15NG-F [M], [H]
L33	6200002850	S.COIL	NL 252018T-R82J
L35	6200002840	S.COIL	NL 252018T-R22J
L36	6200002860	S.COIL	NL 252018T-4R7J

S.=Surface mount

[MAIN UNIT]

REF NO.	ORDER NO.	DESCRIPTION	
L37	6200006980	S.COIL	ELJRE R10G-F
L38	6200005690	S.COIL	ELJRE 18NG-F
R1	7030000620	S.RESISTOR	MCR10EZHZ 100 kΩ
R2	7030000260	S.RESISTOR	MCR10EZHZ 100 Ω (101)
R3	7030000220	S.RESISTOR	MCR10EZHZ 47 Ω (470) [25W]
	7030000280	S.RESISTOR	MCR10EZHZ 150 Ω (151) [45W]
R4	7030003320	S.RESISTOR	ERJ3GEYJ 101 V (100 Ω)
R5	7030003320	S.RESISTOR	ERJ3GEYJ 101 V (100 Ω)
R6	7030003320	S.RESISTOR	ERJ3GEYJ 101 V (100 Ω)
R7	7030003320	S.RESISTOR	ERJ3GEYJ 101 V (100 Ω) [25W]
	7030003340	S.RESISTOR	ERJ3GEYJ 151 V (150 Ω) [45W]
R8	7030001170	S.RESISTOR	MCR50JZHZ 220 Ω (221)
R9	7030001170	S.RESISTOR	MCR50JZHZ 220 Ω (221)
R10	7030003470	S.RESISTOR	ERJ3GEYJ 182 V (1.8 kΩ)
R11	7030003720	S.RESISTOR	ERJ3GEYJ 224 V (220 kΩ)
R12	7030003560	S.RESISTOR	ERJ3GEYJ 103 V (10 kΩ)
R13	7030003720	S.RESISTOR	ERJ3GEYJ 224 V (220 kΩ)
R14	7030003560	S.RESISTOR	ERJ3GEYJ 103 V (10 kΩ)
R15	7030003670	S.RESISTOR	ERJ3GEYJ 823 V (82 kΩ)
R16	7030003340	S.RESISTOR	ERJ3GEYJ 151 V (150 Ω)
R17	7030004050	S.RESISTOR	ERJ3GEYJ 1R0 V (1 Ω)
R18	7030003560	S.RESISTOR	ERJ3GEYJ 103 V (10 kΩ)
R19	7030003720	S.RESISTOR	ERJ3GEYJ 224 V (220 kΩ)
R20	7030003440	S.RESISTOR	ERJ3GEYJ 102 V (1 kΩ)
R21	7030003720	S.RESISTOR	ERJ3GEYJ 224 V (220 kΩ)
R22	7030003560	S.RESISTOR	ERJ3GEYJ 103 V (10 kΩ)
R23	7030003720	S.RESISTOR	ERJ3GEYJ 224 V (220 kΩ)
R24	7030003560	S.RESISTOR	ERJ3GEYJ 103 V (10 kΩ)
R25	7030003520	S.RESISTOR	ERJ3GEYJ 472 V (4.7 kΩ)
R29	7030003330	S.RESISTOR	ERJ3GEYJ 121 V (120 Ω)
R30	7030003440	S.RESISTOR	ERJ3GEYJ 102 V (1 kΩ)
R31	7030003320	S.RESISTOR	ERJ3GEYJ 101 V (100 Ω)
R32	7030003320	S.RESISTOR	ERJ3GEYJ 101 V (100 Ω)
R33	7030003340	S.RESISTOR	ERJ3GEYJ 151 V (150 Ω)
R34	7030003690	S.RESISTOR	ERJ3GEYJ 124 V (120 kΩ)
R35	7030003440	S.RESISTOR	ERJ3GEYJ 102 V (1 kΩ)
R36	7030003510	S.RESISTOR	ERJ3GEYJ 392 V (3.9 kΩ)
R37	7030003500	S.RESISTOR	ERJ3GEYJ 332 V (3.3 kΩ) [N/W]
	7030003520	S.RESISTOR	ERJ3GEYJ 472 V (4.7 kΩ) [N/M]
R38	7030003680	S.RESISTOR	ERJ3GEYJ 104 V (100 kΩ)
R39	7030003280	S.RESISTOR	ERJ3GEYJ 470 V (47 Ω)
R40	7030003460	S.RESISTOR	ERJ3GEYJ 152 V (1.5 kΩ)
R41	7030003640	S.RESISTOR	ERJ3GEYJ 473 V (47 kΩ)
R42	7030003640	S.RESISTOR	ERJ3GEYJ 473 V (47 kΩ)
R43	7030003400	S.RESISTOR	ERJ3GEYJ 471 V (470 Ω)
R44	7030003640	S.RESISTOR	ERJ3GEYJ 473 V (47 kΩ)
R45	7030003620	S.RESISTOR	ERJ3GEYJ 333 V (33 kΩ)
R46	7030003460	S.RESISTOR	ERJ3GEYJ 152 V (1.5 kΩ)
R47	7030003500	S.RESISTOR	ERJ3GEYJ 332 V (3.3 kΩ)
R50	7030003560	S.RESISTOR	ERJ3GEYJ 103 V (10 kΩ)
R52	7030003560	S.RESISTOR	ERJ3GEYJ 103 V (10 kΩ)
R53	7030003320	S.RESISTOR	ERJ3GEYJ 101 V (100 Ω)
R54	7030003560	S.RESISTOR	ERJ3GEYJ 103 V (10 kΩ)
R55	7030003480	S.RESISTOR	ERJ3GEYJ 222 V (2.2 kΩ) [L]
	7030003440	S.RESISTOR	ERJ3GEYJ 102 V (1 kΩ) [M], [H]
R56	7030003700	S.RESISTOR	ERJ3GEYJ 154 V (150 kΩ)
R57	7030003560	S.RESISTOR	ERJ3GEYJ 103 V (10 kΩ) [25W]
R58	7030003280	S.RESISTOR	ERJ3GEYJ 470 V (47 Ω) [L]
	7030003320	S.RESISTOR	ERJ3GEYJ 101 V (100 Ω) [M], [H]
R59	7030003560	S.RESISTOR	ERJ3GEYJ 103 V (10 kΩ) [25W]
	7030003570	S.RESISTOR	ERJ3GEYJ 123 V (12 kΩ) [45W]
R61	7030003290	S.RESISTOR	ERJ3GEYJ 560 V (56 Ω) [25W]
	7030003340	S.RESISTOR	ERJ3GEYJ 151 V (150 Ω) [45W]
R62	7030003570	S.RESISTOR	ERJ3GEYJ 123 V (12 kΩ) [25W]
	7030003600	S.RESISTOR	ERJ3GEYJ 223 V (22 kΩ) [45W]
R65	7030003360	S.RESISTOR	ERJ3GEYJ 221 V (220 Ω) [25W]
	7030003340	S.RESISTOR	ERJ3GEYJ 151 V (150 Ω) [45W]
R66	7030003680	S.RESISTOR	ERJ3GEYJ 104 V (100 kΩ)
R67	7030003560	S.RESISTOR	ERJ3GEYJ 103 V (10 kΩ)
R68	7030003440	S.RESISTOR	ERJ3GEYJ 102 V (1 kΩ)
R69	7030003520	S.RESISTOR	ERJ3GEYJ 472 V (4.7 kΩ)
R70	7030003320	S.RESISTOR	ERJ3GEYJ 101 V (100 Ω)
R71	7030003260	S.RESISTOR	ERJ3GEYJ 330 V (33 Ω)
R72	7030003400	S.RESISTOR	ERJ3GEYJ 471 V (470 Ω)
R73	7030003360	S.RESISTOR	ERJ3GEYJ 221 V (220 Ω)
R74	7030003680	S.RESISTOR	ERJ3GEYJ 104 V (100 kΩ) [L], [M]-45W
	7030003660	S.RESISTOR	ERJ3GEYJ 683 V (68 kΩ) [M]-25W, [H]
R75	7030003700	S.RESISTOR	ERJ3GEYJ 154 V (150 kΩ)

[MAIN UNIT]

REF NO.	ORDER NO.	DESCRIPTION	
R76	7030003360	S.RESISTOR	ERJ3GEYJ 221 V (220 Ω)
R77	7030003560	S.RESISTOR	ERJ3GEYJ 103 V (10 kΩ)
R78	7030003410	S.RESISTOR	ERJ3GEYJ 561 V (560 Ω)
R79	7030003500	S.RESISTOR	ERJ3GEYJ 332 V (3.3 kΩ)
R80	7030003440	S.RESISTOR	ERJ3GEYJ 102 V (1 kΩ)
R81	7030003200	S.RESISTOR	ERJ3GEYJ 100 V (10 Ω)
R82	7030004040	S.RESISTOR	ERJ3GEYJ 4R7 V (4.7 Ω)
R83	7030003500	S.RESISTOR	ERJ3GEYJ 332 V (3.3 kΩ)
R84	7030003500	S.RESISTOR	ERJ3GEYJ 332 V (3.3 kΩ)
R85	7030003500	S.RESISTOR	ERJ3GEYJ 332 V (3.3 kΩ)
R86	7030003720	S.RESISTOR	ERJ3GEYJ 224 V (220 kΩ)
R88	7030003580	S.RESISTOR	ERJ3GEYJ 153 V (15 kΩ)
R89	7030003560	S.RESISTOR	ERJ3GEYJ 103 V (10 kΩ)
R90	7030003680	S.RESISTOR	ERJ3GEYJ 104 V (100 kΩ)
R91	7030003600	S.RESISTOR	ERJ3GEYJ 223 V (22 kΩ) [L]
	7030003640	S.RESISTOR	ERJ3GEYJ 473 V (47 kΩ) [M], [H]
R92	7030003690	S.RESISTOR	ERJ3GEYJ 124 V (120 kΩ)
R93	7030003280	S.RESISTOR	ERJ3GEYJ 470 V (47 Ω)
R94	7030003280	S.RESISTOR	ERJ3GEYJ 470 V (47 Ω)
R95	7030003400	S.RESISTOR	ERJ3GEYJ 471 V (470 Ω)
R96	7030003520	S.RESISTOR	ERJ3GEYJ 472 V (4.7 kΩ)
R97	7030003200	S.RESISTOR	ERJ3GEYJ 100 V (10 Ω)
R98	7030003480	S.RESISTOR	ERJ3GEYJ 222 V (2.2 kΩ)
R99	7030003440	S.RESISTOR	ERJ3GEYJ 102 V (1 kΩ)
R100	7030003640	S.RESISTOR	ERJ3GEYJ 473 V (47 kΩ)
R101	7030003440	S.RESISTOR	ERJ3GEYJ 102 V (1 kΩ)
R102	7030003580	S.RESISTOR	ERJ3GEYJ 153 V (15 kΩ)
R104	7030003450	S.RESISTOR	ERJ3GEYJ 122 V (1.2 kΩ)
R105	7030003640	S.RESISTOR	ERJ3GEYJ 473 V (47 kΩ)
R106	7030003670	S.RESISTOR	ERJ3GEYJ 823 V (82 kΩ)
R107	7030003640	S.RESISTOR	ERJ3GEYJ 473 V (47 kΩ)
R108	7030003600	S.RESISTOR	ERJ3GEYJ 223 V (22 kΩ)
R109	7410000950	S.ARRAY	EXB-V8V 102JV
R110	7030003280	S.RESISTOR	ERJ3GEYJ 470 V (47 Ω)
R111	7030003600	S.RESISTOR	ERJ3GEYJ 223 V (22 kΩ)
R112	7030003560	S.RESISTOR	ERJ3GEYJ 103 V (10 kΩ)
R113	7030003750	S.RESISTOR	ERJ3GEYJ 394 V (390 kΩ)
R115	7030003570	S.RESISTOR	ERJ3GEYJ 123 V (12 kΩ)
R116	7030003460	S.RESISTOR	ERJ3GEYJ 152 V (1.5 kΩ)
R117	7030003530	S.RESISTOR	ERJ3GEYJ 562 V (5.6 kΩ)
R118	7030003660	S.RESISTOR	ERJ3GEYJ 683 V (68 kΩ)
R119	7030003710	S.RESISTOR	ERJ3GEYJ 184 V (180 kΩ)
R120	7030003680	S.RESISTOR	ERJ3GEYJ 104 V (100 kΩ)
R121	7030003560	S.RESISTOR	ERJ3GEYJ 103 V (10 kΩ)
R122	7030003560	S.RESISTOR	ERJ3GEYJ 103 V (10 kΩ)
R123	7030003520	S.RESISTOR	ERJ3GEYJ 472 V (4.7 kΩ)
R124	7030003620	S.RESISTOR	ERJ3GEYJ 333 V (33 kΩ)
R125	7030003600	S.RESISTOR	ERJ3GEYJ 223 V (22 kΩ)
R126	7030003600	S.RESISTOR	ERJ3GEYJ 223 V (22 kΩ)
R127	7030003600	S.RESISTOR	ERJ3GEYJ 223 V (22 kΩ)
R128	7030003640	S.RESISTOR	ERJ3GEYJ 473 V (47 kΩ)
R129	7030003760	S.RESISTOR	ERJ3GEYJ 474 V (470 kΩ)
R130	7030003610	S.RESISTOR	ERJ3GEYJ 273 V (27 kΩ)
R131	7030003660	S.RESISTOR	ERJ3GEYJ 683 V (68 kΩ)
R132	7030003650	S.RESISTOR	ERJ3GEYJ 563 V (56 kΩ)
R133	7030003720	S.RESISTOR	ERJ3GEYJ 224 V (220 kΩ)
R134	7030003700	S.RESISTOR	ERJ3GEYJ 154 V (150 kΩ)
R135	7030003680	S.RESISTOR	ERJ3GEYJ 104 V (100 kΩ)
R136	7030003440	S.RESISTOR	ERJ3GEYJ 102 V (1 kΩ)
R137	7410000770	S.ARRAY	EXB-V4V 102JV (1 kΩ)
R138	7030003640	S.RESISTOR	ERJ3GEYJ 473 V (47 kΩ)
R139	7030003640	S.RESISTOR	ERJ3GEYJ 473 V (47 kΩ)
R140	7030003640	S.RESISTOR	ERJ3GEYJ 473 V (47 kΩ)
R141	7410000750	S.ARRAY	EXB-V4V 104JV (100 kΩ)
R142	7410000750	S.ARRAY	EXB-V4V 104JV (100 kΩ)
R143	7410000750	S.ARRAY	EXB-V4V 104JV (100 kΩ)
R144	7410000750	S.ARRAY	EXB-V4V 104JV (100 kΩ)
R145	7410000750	S.ARRAY	EXB-V4V 104JV (100 kΩ)
R146	7030003680	S.RESISTOR	ERJ3GEYJ 104 V (100 kΩ)
R147	7410000750	S.ARRAY	EXB-V4V 104JV (100 kΩ)
R148	7030003680	S.RESISTOR	ERJ3GEYJ 104 V (100 kΩ)
R149	7030003560	S.RESISTOR	ERJ3GEYJ 103 V (10 kΩ)
R150	7030003680	S.RESISTOR	ERJ3GEYJ 104 V (100 kΩ)
R151	7410000750	S.ARRAY	EXB-V4V 104JV (100 kΩ)
R152	7410000750	S.ARRAY	EXB-V4V 104JV (100 kΩ)
R153	7030003680	S.RESISTOR	ERJ3GEYJ 104 V (100 kΩ)
R154	7410000750	S.ARRAY	EXB-V4V 104JV (100 kΩ)
R155	7410000750	S.ARRAY	EXB-V4V 104JV (100 kΩ)
R156	7030003520	S.RESISTOR	ERJ3GEYJ 472 V (4.7 kΩ)
R157	7030003560	S.RESISTOR	ERJ3GEYJ 103 V (10 kΩ)
R158	7030003560	S.RESISTOR	ERJ3GEYJ 103 V (10 kΩ)
R159	7030003560	S.RESISTOR	ERJ3GEYJ 103 V (10 kΩ)

S.=Surface mount

[MAIN UNIT]

REF NO.	ORDER NO.	DESCRIPTION
R173	7030003800	S.RESISTOR ERJ3GEYJ 105 V (1 MΩ)
R174	7030003800	S.RESISTOR ERJ3GEYJ 105 V (1 MΩ)
R175	7030003800	S.RESISTOR ERJ3GEYJ 105 V (1 MΩ)
R176	7030003740	S.RESISTOR ERJ3GEYJ 334 V (330 kΩ)
R177	7030003740	S.RESISTOR ERJ3GEYJ 334 V (330 kΩ)
R178	7030003740	S.RESISTOR ERJ3GEYJ 334 V (330 kΩ)
R179	7030003620	S.RESISTOR ERJ3GEYJ 333 V (33 kΩ)
R180	7030003530	S.RESISTOR ERJ3GEYJ 562 V (5.6 kΩ)
R181	7030003660	S.RESISTOR ERJ3GEYJ 683 V (68 kΩ)
R182	7030003660	S.RESISTOR ERJ3GEYJ 683 V (68 kΩ)
R185	7030003620	S.RESISTOR ERJ3GEYJ 333 V (33 kΩ)
R186	7030003630	S.RESISTOR ERJ3GEYJ 393 V (39 kΩ)
R187	7030003650	S.RESISTOR ERJ3GEYJ 563 V (56 kΩ)
R188	7030003590	S.RESISTOR ERJ3GEYJ 183 V (18 kΩ)
R189	7030003610	S.RESISTOR ERJ3GEYJ 273 V (27 kΩ)
R190	7030004040	S.RESISTOR ERJ3GEYJ 4R7 V (4.7 Ω)
R191	7030003720	S.RESISTOR ERJ3GEYJ 224 V (220 kΩ)
R192	7030003720	S.RESISTOR ERJ3GEYJ 224 V (220 kΩ)
R193	7030003680	S.RESISTOR ERJ3GEYJ 104 V (100 kΩ)
R194	7030003480	S.RESISTOR ERJ3GEYJ 222 V (2.2 kΩ)
R195	7030003440	S.RESISTOR ERJ3GEYJ 102 V (1 kΩ)
R196	7030003600	S.RESISTOR ERJ3GEYJ 223 V (22 kΩ)
R197	7030003560	S.RESISTOR ERJ3GEYJ 103 V (10 kΩ)
R198	7030003560	S.RESISTOR ERJ3GEYJ 103 V (10 kΩ)
R199	7030003560	S.RESISTOR ERJ3GEYJ 103 V (10 kΩ)
R200	7030003560	S.RESISTOR ERJ3GEYJ 103 V (10 kΩ)
R201	7030003400	S.RESISTOR ERJ3GEYJ 471 V (470 Ω)
R202	7030000460	S.RESISTOR MCR10EZHZ 4.7 kΩ
R203	7030000460	S.RESISTOR MCR10EZHZ 4.7 kΩ
R204	7030000460	S.RESISTOR MCR10EZHZ 4.7 kΩ
R205	7030000460	S.RESISTOR MCR10EZHZ 4.7 kΩ
R206	7030003760	S.RESISTOR ERJ3GEYJ 474 V (470 kΩ)
R207	7030003720	S.RESISTOR ERJ3GEYJ 224 V (220 kΩ)
R208	7030004040	S.RESISTOR ERJ3GEYJ 4R7 V (4.7 Ω)
R209	7510001470	S.THERMISTOR NTCG20 4AG 473JT
R210	7030005871	S.RESISTOR ERA3YKD 104V (100 kΩ)
R215	7030003510	S.RESISTOR ERJ3GEYJ 392 V (3.9 kΩ)
R216	7030003620	S.RESISTOR ERJ3GEYJ 333 V (33 kΩ)
R217	7030003610	S.RESISTOR ERJ3GEYJ 273 V (27 kΩ)
R218	7030003610	S.RESISTOR ERJ3GEYJ 273 V (27 kΩ)
R219	7030003600	S.RESISTOR ERJ3GEYJ 223 V (22 kΩ)
R220	7030003650	S.RESISTOR ERJ3GEYJ 563 V (56 kΩ)
R222	7030003400	S.RESISTOR ERJ3GEYJ 471 V (470 Ω)
R223	7030003440	S.RESISTOR ERJ3GEYJ 102 V (1 kΩ)
R224	7030003280	S.RESISTOR ERJ3GEYJ 470 V (47 Ω)
R225	7030003560	S.RESISTOR ERJ3GEYJ 103 V (10 kΩ)
R226	7030003680	S.RESISTOR ERJ3GEYJ 104 V (100 kΩ)
R227	7030003800	S.RESISTOR ERJ3GEYJ 105 V (1 MΩ)
R228	7030003680	S.RESISTOR ERJ3GEYJ 104 V (100 kΩ)
R229	7030003800	S.RESISTOR ERJ3GEYJ 105 V (1 MΩ)
R230	7030003560	S.RESISTOR ERJ3GEYJ 103 V (10 kΩ)
R231	7030003440	S.RESISTOR ERJ3GEYJ 102 V (1 kΩ)
R232	7030003290	S.RESISTOR ERJ3GEYJ 560 V (56 Ω)
R233	7030003680	S.RESISTOR ERJ3GEYJ 104 V (100 kΩ)
R234	7030003640	S.RESISTOR ERJ3GEYJ 473 V (47 kΩ)
R235	7030003440	S.RESISTOR ERJ3GEYJ 102 V (1 kΩ)
R236	7030003450	S.RESISTOR ERJ3GEYJ 122 V (1.2 kΩ)
R237	7030003780	S.RESISTOR ERJ3GEYJ 684 V (680 kΩ)
R238	7030003680	S.RESISTOR ERJ3GEYJ 104 V (100 kΩ)
R239	7030003520	S.RESISTOR ERJ3GEYJ 472 V (4.7 kΩ)
R240	7030003680	S.RESISTOR ERJ3GEYJ 104 V (100 kΩ)
R241	7030003680	S.RESISTOR ERJ3GEYJ 104 V (100 kΩ)
R242	7030003630	S.RESISTOR ERJ3GEYJ 393 V (39 kΩ)
R243	7030003670	S.RESISTOR ERJ3GEYJ 823 V (82 kΩ)
R244	7030003750	S.RESISTOR ERJ3GEYJ 394 V (390 kΩ)
R245	7030003710	S.RESISTOR ERJ3GEYJ 184 V (180 kΩ)
R246	7030003460	S.RESISTOR ERJ3GEYJ 152 V (1.5 kΩ)
R247	7030003600	S.RESISTOR ERJ3GEYJ 223 V (22 kΩ)
R248	7030003600	S.RESISTOR ERJ3GEYJ 223 V (22 kΩ)
R249	7030003600	S.RESISTOR ERJ3GEYJ 223 V (22 kΩ)
R250	7030003690	S.RESISTOR ERJ3GEYJ 124 V (120 kΩ)
R251	7030003660	S.RESISTOR ERJ3GEYJ 683 V (68 kΩ)
R252	7030003720	S.RESISTOR ERJ3GEYJ 224 V (220 kΩ)
R253	7030003590	S.RESISTOR ERJ3GEYJ 183 V (18 kΩ)
R254	7030003640	S.RESISTOR ERJ3GEYJ 473 V (47 kΩ)
R255	7030003640	S.RESISTOR ERJ3GEYJ 473 V (47 kΩ)
R256	7030003680	S.RESISTOR ERJ3GEYJ 104 V (100 kΩ)
R257	7030003760	S.RESISTOR ERJ3GEYJ 474 V (470 kΩ)
R258	7030003400	S.RESISTOR ERJ3GEYJ 471 V (470 Ω)
R259	7030003530	S.RESISTOR ERJ3GEYJ 562 V (5.6 kΩ)
R260	7030003620	S.RESISTOR ERJ3GEYJ 333 V (33 kΩ)
R261	7030003620	S.RESISTOR ERJ3GEYJ 333 V (33 kΩ)

[MAIN UNIT]

REF NO.	ORDER NO.	DESCRIPTION
R262	7030003620	S.RESISTOR ERJ3GEYJ 333 V (33 kΩ)
R263	7030003600	S.RESISTOR ERJ3GEYJ 223 V (22 kΩ)
R264	7030003490	S.RESISTOR ERJ3GEYJ 272 V (2.7 kΩ)
R265	7030003630	S.RESISTOR ERJ3GEYJ 393 V (39 kΩ)
R266	7030003510	S.RESISTOR ERJ3GEYJ 392 V (3.9 kΩ)
R267	7030003600	S.RESISTOR ERJ3GEYJ 223 V (22 kΩ)
R268	7030003650	S.RESISTOR ERJ3GEYJ 563 V (56 kΩ)
R269	7030003710	S.RESISTOR ERJ3GEYJ 184 V (180 kΩ)
R270	7030003640	S.RESISTOR ERJ3GEYJ 473 V (47 kΩ)
R271	7030003640	S.RESISTOR ERJ3GEYJ 473 V (47 kΩ)
R272	7030003640	S.RESISTOR ERJ3GEYJ 473 V (47 kΩ)
R273	7030003520	S.RESISTOR ERJ3GEYJ 472 V (4.7 kΩ)
R274	7030003640	S.RESISTOR ERJ3GEYJ 473 V (47 kΩ)
R275	7030003610	S.RESISTOR ERJ3GEYJ 273 V (27 kΩ)
R276	7030003570	S.RESISTOR ERJ3GEYJ 123 V (12 kΩ)
R277	7030003570	S.RESISTOR ERJ3GEYJ 123 V (12 kΩ)
R278	7030003570	S.RESISTOR ERJ3GEYJ 123 V (12 kΩ)
R280	7030003200	S.RESISTOR ERJ3GEYJ 100 V (10 Ω)
R281	7030003560	S.RESISTOR ERJ3GEYJ 103 V (10 kΩ)
R282	7030003680	S.RESISTOR ERJ3GEYJ 104 V (100 kΩ)
R284	7030003440	S.RESISTOR ERJ3GEYJ 102 V (1 kΩ)
R285	7030003520	S.RESISTOR ERJ3GEYJ 472 V (4.7 kΩ)
R286	7030003440	S.RESISTOR ERJ3GEYJ 102 V (1 kΩ)
R287	7030003560	S.RESISTOR ERJ3GEYJ 103 V (10 kΩ)
R288	7030003560	S.RESISTOR ERJ3GEYJ 103 V (10 kΩ)
R289	7030003320	S.RESISTOR ERJ3GEYJ 101 V (100 Ω)
R290	7030003400	S.RESISTOR ERJ3GEYJ 471 V (470 Ω)
R291	7030003680	S.RESISTOR ERJ3GEYJ 104 V (100 kΩ)
R292	7030003550	S.RESISTOR ERJ3GEYJ 822 V (8.2 kΩ)
R293	7410000950	S.ARRAY EXB-V8V 102JV
R294	7410000950	S.ARRAY EXB-V8V 102JV
R295	7410000950	S.ARRAY EXB-V8V 102JV
R296	7410000770	S.ARRAY EXB-V4V 102JV (1 kΩ)
R297	7030005651	S.RESISTOR ERA3YKD 304V (300 kΩ)
R298	7030005871	S.RESISTOR ERA3YKD 104V (100 kΩ)
R299	7030003680	S.RESISTOR ERJ3GEYJ 104 V (100 kΩ)
R302	7030003560	S.RESISTOR ERJ3GEYJ 103 V (10 kΩ)
R303	7030003680	S.RESISTOR ERJ3GEYJ 104 V (100 kΩ)
R304	7030003650	S.RESISTOR ERJ3GEYJ 563 V (56 kΩ)
R305	7030003720	S.RESISTOR ERJ3GEYJ 224 V (220 kΩ)
R306	7030003320	S.RESISTOR ERJ3GEYJ 101 V (100 Ω)
R307	7030003600	S.RESISTOR ERJ3GEYJ 223 V (22 kΩ)
R308	7030003380	S.RESISTOR ERJ3GEYJ 331 V (330 Ω)
R309	7030003380	S.RESISTOR ERJ3GEYJ 331 V (330 Ω)
R310	7030003430	S.RESISTOR ERJ3GEYJ 821 V (820 Ω)
R310	7030003230	S.RESISTOR ERJ3GEYJ 180 V (18 Ω)
R310	7030004030	S.RESISTOR ERJ3GEYJ 5R6 V (5.6 Ω)
R311	7030003380	S.RESISTOR ERJ3GEYJ 331 V (330 Ω)
R311	7030003430	S.RESISTOR ERJ3GEYJ 821 V (820 Ω)
R312	7030003510	S.RESISTOR ERJ3GEYJ 392 V (3.9 kΩ)
R316	7030003680	S.RESISTOR ERJ3GEYJ 104 V (100 kΩ)
R317	7030003680	S.RESISTOR ERJ3GEYJ 104 V (100 kΩ)
R318	7030003570	S.RESISTOR ERJ3GEYJ 123 V (12 kΩ)
R319	7030003640	S.RESISTOR ERJ3GEYJ 473 V (47 kΩ)
R320	7030003500	S.RESISTOR ERJ3GEYJ 332 V (3.3 kΩ)
R321	7030003660	S.RESISTOR ERJ3GEYJ 683 V (68 kΩ)
R322	7030003680	S.RESISTOR ERJ3GEYJ 104 V (100 kΩ)
R323	7030003680	S.RESISTOR ERJ3GEYJ 104 V (100 kΩ)
R324	7030003640	S.RESISTOR ERJ3GEYJ 473 V (47 kΩ)
R325	7520000160	S.POSISTOR PRF21BD471QB3RA
C1	4030011090	S.CERAMIC GRM31M2C2H7R0DV01L
C2	4030011090	S.CERAMIC GRM31M2C2H7R0DV01L
C3	4030006860	S.CERAMIC C1608 JB 1H 102K-T
C4	4030011770	S.CERAMIC C1608 CH 1H 060B-T
C5	4030006860	S.CERAMIC C1608 JB 1H 102K-T
C6	4030011050	S.CERAMIC GRM31M3C2H3R0CY21L
C7	4030011090	S.CERAMIC GRM31M2C2H7R0DV01L [L]
C7	4030011080	S.CERAMIC GRM31M2C2H6R0DV01L [M], [H]
C8	4030011040	S.CERAMIC GRM31M4C2H2R0CY21L
C9	4030011080	S.CERAMIC GRM31M2C2H6R0DV01L
C10	4030006860	S.CERAMIC C1608 JB 1H 102K-T
C11	4030006860	S.CERAMIC C1608 JB 1H 102K-T
C12	4030006850	S.CERAMIC C1608 JB 1H 471K-T
C13	4030007090	S.CERAMIC C1608 CH 1H 470J-T
C14	4030011240	S.CERAMIC GRM31M2C2H470JV01L [25W]
C15	4030011100	S.CERAMIC GRM31M2C2H8R0DV01L
C16	4030011040	S.CERAMIC GRM31M4C2H2R0CY21L [L]
C16	4030011020	S.CERAMIC GRM31M4C2H1R0CY21L [M], [H]
C17	4030007010	S.CERAMIC C1608 CH 1H 100D-T [25W]
C17	4030007000	S.CERAMIC C1608 CH 1H 090D-T [45W]

S.=Surface mount

[MAIN UNIT]

REF NO.	ORDER NO.	DESCRIPTION	
C18	4030009910	S.CERAMIC C1608 CH 1H 040B-T	[L]
	4030009530	S.CERAMIC C1608 CH 1H 030B-T	[M], [H]
C19	4030006860	S.CERAMIC C1608 JB 1H 102K-T	
C20	4030009920	S.CERAMIC C1608 CH 1H 050B-T	[L]
	4030007010	S.CERAMIC C1608 CH 1H 100D-T	[M], [H]
C21	4030009540	S.CERAMIC C1608 CH 1H 1R5B-T	[L]
	4030009560	S.CERAMIC C1608 CH 1H R75B-T	[M], [H]
C22	4030009560	S.CERAMIC C1608 CH 1H R75B-T	
C23	4030006860	S.CERAMIC C1608 JB 1H 102K-T	
C24	4030006860	S.CERAMIC C1608 JB 1H 102K-T	
C25	4030009550	S.CERAMIC C1608 CH 1H 2R5B-T	
C26	4030006990	S.CERAMIC C1608 CH 1H 080D-T	[L]
	4030007010	S.CERAMIC C1608 CH 1H 100D-T	[M], [H]
C27	4030006860	S.CERAMIC C1608 JB 1H 102K-T	
C28	4030006860	S.CERAMIC C1608 JB 1H 102K-T	
C29	4030009530	S.CERAMIC C1608 CH 1H 030B-T	[L]
	4030009510	S.CERAMIC C1608 CH 1H 010B-T	[M], [H]
C30	4030009920	S.CERAMIC C1608 CH 1H 050B-T	
C32	4030006860	S.CERAMIC C1608 JB 1H 102K-T	
C33	4030007090	S.CERAMIC C1608 CH 1H 470J-T	
C34	4030006860	S.CERAMIC C1608 JB 1H 102K-T	
C35	4030006860	S.CERAMIC C1608 JB 1H 102K-T	
C36	4030009530	S.CERAMIC C1608 CH 1H 030B-T	[L]
	4030009520	S.CERAMIC C1608 CH 1H 020B-T	[M], [H]
C37	4030006860	S.CERAMIC C1608 JB 1H 102K-T	
C38	4030006860	S.CERAMIC C1608 JB 1H 102K-T	
C39	4030006990	S.CERAMIC C1608 CH 1H 080D-T	[L]
	4030007010	S.CERAMIC C1608 CH 1H 100D-T	[M], [H]
C40	4030009560	S.CERAMIC C1608 CH 1H R75B-T	
C41	4030007050	S.CERAMIC C1608 CH 1H 220J-T	
C42	4030006860	S.CERAMIC C1608 JB 1H 102K-T	
C43	4030006860	S.CERAMIC C1608 JB 1H 102K-T	
C44	4030009350	S.CERAMIC C1608 CH 1H 3R5B-T	[L]
	4030009550	S.CERAMIC C1608 CH 1H 2R5B-T	[M], [H]
C45	4030006990	S.CERAMIC C1608 CH 1H 080D-T	[L]
	4030007010	S.CERAMIC C1608 CH 1H 100D-T	[M], [H]
C46	4030006860	S.CERAMIC C1608 JB 1H 102K-T	
C47	4030006860	S.CERAMIC C1608 JB 1H 102K-T	
C48	4030007050	S.CERAMIC C1608 CH 1H 220J-T	
C49	4030009920	S.CERAMIC C1608 CH 1H 050B-T	
C50	4030006860	S.CERAMIC C1608 JB 1H 102K-T	
C51	4030006860	S.CERAMIC C1608 JB 1H 102K-T	
C52	4030007090	S.CERAMIC C1608 CH 1H 470J-T	
C53	4030006900	S.CERAMIC C1608 JB 1H 103K-T	
C54	4030006860	S.CERAMIC C1608 JB 1H 102K-T	
C56	4030007050	S.CERAMIC C1608 CH 1H 220J-T	
C58	4030006860	S.CERAMIC C1608 JB 1H 102K-T	
C59	4030011600	S.CERAMIC C1608 JB 1E 104K-T	
C60	4030006860	S.CERAMIC C1608 JB 1H 102K-T	
C61	4030007130	S.CERAMIC C1608 CH 1H 101J-T	
C62	4030007120	S.CERAMIC C1608 CH 1H 820J-T	
C63	4030006860	S.CERAMIC C1608 JB 1H 102K-T	
C64	4030011340	S.CERAMIC C1608 CH 1H 471J-T	
C65	4030006860	S.CERAMIC C1608 JB 1H 102K-T	
C66	4030006860	S.CERAMIC C1608 JB 1H 102K-T	
C67	4030006860	S.CERAMIC C1608 JB 1H 102K-T	
C69	4030007170	S.CERAMIC C1608 CH 1H 221J-T	
C70	4030007170	S.CERAMIC C1608 CH 1H 221J-T	
C71	4030011600	S.CERAMIC C1608 JB 1E 104K-T	
C72	4030011600	S.CERAMIC C1608 JB 1E 104K-T	
C74	4030011600	S.CERAMIC C1608 JB 1E 104K-T	
C75	4550006050	S.TANTALUM TEMSVA OJ 106M8L	
C76	4030006900	S.CERAMIC C1608 JB 1H 103K-T	
C77	4030006860	S.CERAMIC C1608 JB 1H 102K-T	
C78	4030006860	S.CERAMIC C1608 JB 1H 102K-T	
C79	4030011810	S.CERAMIC C1608 JB 1A 224K-T	[L]
	4030011600	S.CERAMIC C1608 JB 1E 104K-T	[M], [H]
C80	4030008920	S.CERAMIC C1608 JB 1H 473K-T	[L]
	4030011600	S.CERAMIC C1608 JB 1E 104K-T	[M], [H]
C81	4030006860	S.CERAMIC C1608 JB 1H 102K-T	
C82	4030011060	S.CERAMIC GRM31M2C2H4R0CY21L	[25W]
C83	4030011050	S.CERAMIC GRM31M3C2H3R0CY21L	[25W]
C84	4030007090	S.CERAMIC C1608 CH 1H 470J-T	
C85	4030006860	S.CERAMIC C1608 JB 1H 102K-T	
C86	4030007090	S.CERAMIC C1608 CH 1H 470J-T	
C87	4030006860	S.CERAMIC C1608 JB 1H 102K-T	
C89	4030006980	S.CERAMIC C1608 CH 1H 070D-T	[L]
	4030011770	S.CERAMIC C1608 CH 1H 060B-T	[M], [H]
C90	4030006980	S.CERAMIC C1608 CH 1H 070D-T	[L]
	4030011770	S.CERAMIC C1608 CH 1H 060B-T	[M], [H]
C91	4510005630	S.ELECTROLYTIC ECEV1EA330SP	[L]
	4510005750	S.ELECTROLYTIC ECEV1EA220SP	[M], [H]

[MAIN UNIT]

REF NO.	ORDER NO.	DESCRIPTION	
C92	4030009920	S.CERAMIC C1608 CH 1H 050B-T	
C93	4030009910	S.CERAMIC C1608 CH 1H 040B-T	[25W]
	4030009350	S.CERAMIC C1608 CH 1H 3R5B-T	[45W]
C94	4030007090	S.CERAMIC C1608 CH 1H 470J-T	
C95	4030006860	S.CERAMIC C1608 JB 1H 102K-T	
C96	4030006860	S.CERAMIC C1608 JB 1H 102K-T	
C97	4030007090	S.CERAMIC C1608 CH 1H 470J-T	
C98	4030009520	S.CERAMIC C1608 CH 1H 020B-T	[25W]
	4030009920	S.CERAMIC C1608 CH 1H 050B-T	[45W]
C99	4030006860	S.CERAMIC C1608 JB 1H 102K-T	
C100	4030009920	S.CERAMIC C1608 CH 1H 050B-T	
C101	4030006860	S.CERAMIC C1608 JB 1H 102K-T	
C102	4030007020	S.CERAMIC C1608 CH 1H 120J-T	
C103	4030009520	S.CERAMIC C1608 CH 1H 020B-T	
C104	4030006860	S.CERAMIC C1608 JB 1H 102K-T	
C105	4030006860	S.CERAMIC C1608 JB 1H 102K-T	
C106	4030007090	S.CERAMIC C1608 CH 1H 470J-T	
C107	4030006860	S.CERAMIC C1608 JB 1H 102K-T	
C108	4030006900	S.CERAMIC C1608 JB 1H 103K-T	
C109	4030006860	S.CERAMIC C1608 JB 1H 102K-T	
C110	4030006850	S.CERAMIC C1608 JB 1H 471K-T	
C111	4030007090	S.CERAMIC C1608 CH 1H 470J-T	
C113	4030009500	S.CERAMIC C1608 CH 1H 0R5B-T	
C114	4030006990	S.CERAMIC C1608 CH 1H 080D-T	
C115	4030011770	S.CERAMIC C1608 CH 1H 060B-T	
C116	4030006860	S.CERAMIC C1608 JB 1H 102K-T	
C117	4030006850	S.CERAMIC C1608 JB 1H 471K-T	
C118	4030009500	S.CERAMIC C1608 CH 1H 0R5B-T	
C119	4030006860	S.CERAMIC C1608 JB 1H 102K-T	
C120	4030007090	S.CERAMIC C1608 CH 1H 470J-T	
C121	4030007010	S.CERAMIC C1608 CH 1H 100D-T	[L], [H]
	4030006990	S.CERAMIC C1608 CH 1H 080D-T	[M]
C122	4030011770	S.CERAMIC C1608 CH 1H 060B-T	[L], [H]
	4030009920	S.CERAMIC C1608 CH 1H 050B-T	[M]
C123	4030007020	S.CERAMIC C1608 CH 1H 120J-T	[L]
	4030006990	S.CERAMIC C1608 CH 1H 080D-T	[M], [H]
C124	4030011770	S.CERAMIC C1608 CH 1H 060B-T	[L]
	4030009520	S.CERAMIC C1608 CH 1H 020B-T	[M], [H]
C125	4030008220	S.CERAMIC C1608 UJ 1H 070D-T	
C126	4030011770	S.CERAMIC C1608 CH 1H 060B-T	
C127	4030009350	S.CERAMIC C1608 CH 1H 3R5B-T	[L]
C128	4030008220	S.CERAMIC C1608 UJ 1H 070D-T	
C129	4030009500	S.CERAMIC C1608 CH 1H 0R5B-T	
C130	4030007130	S.CERAMIC C1608 CH 1H 101J-T	
C132	4030006860	S.CERAMIC C1608 JB 1H 102K-T	
C133	4610001590	S.TRIMMER TZC3R100A110R00	
C134	4610001920	S.TRIMMER TZC3Z060A110R00	
C136	4030006860	S.CERAMIC C1608 JB 1H 102K-T	
C137	4030006860	S.CERAMIC C1608 JB 1H 102K-T	
C138	4030006860	S.CERAMIC C1608 JB 1H 102K-T	
C139	4030011600	S.CERAMIC C1608 JB 1E 104K-T	
C140	4030011600	S.CERAMIC C1608 JB 1E 104K-T	
C141	4030006860	S.CERAMIC C1608 JB 1H 102K-T	
C142	4030006860	S.CERAMIC C1608 JB 1H 102K-T	
C143	4030006860	S.CERAMIC C1608 JB 1H 102K-T	
C144	4030006900	S.CERAMIC C1608 JB 1H 103K-T	
C145	4030007090	S.CERAMIC C1608 CH 1H 470J-T	
C146	4550000510	S.TANTALUM TESVA 1V 473M1-8L	
C147	4550000560	S.TANTALUM TESVA 1V 334M1-8L	
C148	4510004630	S.ELECTROLYTIC ECEV1CA100SR	
C150	4030007090	S.CERAMIC C1608 CH 1H 470J-T	
C151	4030007090	S.CERAMIC C1608 CH 1H 470J-T	
C152	4030007090	S.CERAMIC C1608 CH 1H 470J-T	
C153	4030007090	S.CERAMIC C1608 CH 1H 470J-T	
C154	4030007090	S.CERAMIC C1608 CH 1H 470J-T	
C155	4030011600	S.CERAMIC C1608 JB 1E 104K-T	
C156	4030007090	S.CERAMIC C1608 CH 1H 470J-T	
C157	4030007130	S.CERAMIC C1608 CH 1H 101J-T	
C158	4030007130	S.CERAMIC C1608 CH 1H 101J-T	
C159	4030011600	S.CERAMIC C1608 JB 1E 104K-T	
C160	4030007000	S.CERAMIC C1608 CH 1H 090D-T	
C161	4030007130	S.CERAMIC C1608 CH 1H 101J-T	
C162	4030006860	S.CERAMIC C1608 JB 1H 102K-T	
C164	4030006860	S.CERAMIC C1608 JB 1H 102K-T	
C165	4030006860	S.CERAMIC C1608 JB 1H 102K-T	
C166	4030006860	S.CERAMIC C1608 JB 1H 102K-T	
C167	4030008890	S.CERAMIC C1608 JB 1H 273K-T	
C168	4030008910	S.CERAMIC C1608 JB 1H 393K-T	
C169	4030008910	S.CERAMIC C1608 JB 1H 393K-T	
C170	4030008900	S.CERAMIC C1608 JB 1H 333K-T	
C171	4030006880	S.CERAMIC C1608 JB 1H 472K-T	
C173	4510004650	S.ELECTROLYTIC ECEV1EA4R7SR	

S.=Surface mount

[MAIN UNIT]

REF NO.	ORDER NO.	DESCRIPTION
C174	4030011600	S.CERAMIC C1608 JB 1E 104K-T
C176	4510005430	S.ELECTROLYTIC ECEV0JA220SR
C177	4030007030	S.CERAMIC C1608 CH 1H 150J-T
C178	4030007040	S.CERAMIC C1608 CH 1H 180J-T
C179	4030006850	S.CERAMIC C1608 JB 1H 471K-T
C180	4030011600	S.CERAMIC C1608 JB 1E 104K-T
C181	4030011600	S.CERAMIC C1608 JB 1E 104K-T
C182	4030011600	S.CERAMIC C1608 JB 1E 104K-T
C183	4030008920	S.CERAMIC C1608 JB 1H 473K-T
C184	4030011600	S.CERAMIC C1608 JB 1E 104K-T
C185	4030011600	S.CERAMIC C1608 JB 1E 104K-T
C186	4030006870	S.CERAMIC C1608 JB 1H 222K-T
C187	4030006870	S.CERAMIC C1608 JB 1H 222K-T
C188	4030011600	S.CERAMIC C1608 JB 1E 104K-T
C189	4030011600	S.CERAMIC C1608 JB 1E 104K-T
C190	4030007130	S.CERAMIC C1608 CH 1H 101J-T
C191	4030008910	S.CERAMIC C1608 JB 1H 393K-T
C192	4030006880	S.CERAMIC C1608 JB 1H 472K-T
C193	4030011600	S.CERAMIC C1608 JB 1E 104K-T
C194	4030007140	S.CERAMIC C1608 CH 1H 121J-T
C195	4030011600	S.CERAMIC C1608 JB 1E 104K-T
C196	4030006900	S.CERAMIC C1608 JB 1H 103K-T
C199	4030007090	S.CERAMIC C1608 CH 1H 470J-T
C200	4030011600	S.CERAMIC C1608 JB 1E 104K-T
C201	4030011600	S.CERAMIC C1608 JB 1E 104K-T
C202	4030011600	S.CERAMIC C1608 JB 1E 104K-T
C203	4030011600	S.CERAMIC C1608 JB 1E 104K-T
C204	4030007090	S.CERAMIC C1608 CH 1H 470J-T
C205	4030007090	S.CERAMIC C1608 CH 1H 470J-T
C206	4030007090	S.CERAMIC C1608 CH 1H 470J-T
C207	4030011600	S.CERAMIC C1608 JB 1E 104K-T
C209	4030007090	S.CERAMIC C1608 CH 1H 470J-T
C214	4030007090	S.CERAMIC C1608 CH 1H 470J-T
C215	4030007090	S.CERAMIC C1608 CH 1H 470J-T
C217	4030007090	S.CERAMIC C1608 CH 1H 470J-T
C219	4030007090	S.CERAMIC C1608 CH 1H 470J-T
C220	4030007090	S.CERAMIC C1608 CH 1H 470J-T
C224	4030007090	S.CERAMIC C1608 CH 1H 470J-T
C227	4030007090	S.CERAMIC C1608 CH 1H 470J-T
C228	4030007090	S.CERAMIC C1608 CH 1H 470J-T
C229	4030007090	S.CERAMIC C1608 CH 1H 470J-T
C231	4030007090	S.CERAMIC C1608 CH 1H 470J-T
C235	4030007090	S.CERAMIC C1608 CH 1H 470J-T
C236	4030007090	S.CERAMIC C1608 CH 1H 470J-T
C237	4030007090	S.CERAMIC C1608 CH 1H 470J-T
C238	4030006860	S.CERAMIC C1608 JB 1H 102K-T
C239	4030006860	S.CERAMIC C1608 JB 1H 102K-T
C240	4030008880	S.CERAMIC C1608 JB 1H 223K-T
C241	4030006860	S.CERAMIC C1608 JB 1H 102K-T
C242	4030010020	S.CERAMIC C1608 JB 1H 122K-T
C243	4030011280	S.CERAMIC C1608 CH 1H 271J-T
C244	4030007100	S.CERAMIC C1608 CH 1H 560J-T
C246	4030010760	S.CERAMIC C1608 CH 1H 331J-T
C247	4030006860	S.CERAMIC C1608 JB 1H 102K-T
C248	4030006860	S.CERAMIC C1608 JB 1H 102K-T
C249	4030006850	S.CERAMIC C1608 JB 1H 471K-T
C250	4030011600	S.CERAMIC C1608 JB 1E 104K-T
C251	4030011600	S.CERAMIC C1608 JB 1E 104K-T
C252	4030011600	S.CERAMIC C1608 JB 1E 104K-T
C253	4030011600	S.CERAMIC C1608 JB 1E 104K-T
C254	4030006860	S.CERAMIC C1608 JB 1H 102K-T
C255	4510005290	S.ELECTROLYTIC ECEV1EA221P
C256	4510006260	S.ELECTROLYTIC ECEV1AA471UP
C257	4030007090	S.CERAMIC C1608 CH 1H 470J-T
C258	4510004510	S.ELECTROLYTIC 25 MV 470 HC
C259	4030006860	S.CERAMIC C1608 JB 1H 102K-T
C260	4030007090	S.CERAMIC C1608 CH 1H 470J-T
C261	4030004760	S.CERAMIC C2012 JF 1H 104Z-T
C262	4030011600	S.CERAMIC C1608 JB 1E 104K-T
C263	4030004760	S.CERAMIC C2012 JF 1H 104Z-T
C264	4030011600	S.CERAMIC C1608 JB 1E 104K-T
C265	4510005290	S.ELECTROLYTIC ECEV1EA221P
C266	4510004630	S.ELECTROLYTIC ECEV1CA100SR
C268	4510004630	S.ELECTROLYTIC ECEV1CA100SR
C269	4030006860	S.CERAMIC C1608 JB 1H 102K-T
C270	4030006860	S.CERAMIC C1608 JB 1H 102K-T
C271	4510005860	S.ELECTROLYTIC ECEV1HA2R2SR
C272	4510005860	S.ELECTROLYTIC ECEV1HA2R2SR
C273	4030006860	S.CERAMIC C1608 JB 1H 102K-T
C274	4510004650	S.ELECTROLYTIC ECEV1EA4R7SR
C278	4030011600	S.CERAMIC C1608 JB 1E 104K-T
C279	4030011600	S.CERAMIC C1608 JB 1E 104K-T

[MAIN UNIT]

REF NO.	ORDER NO.	DESCRIPTION
C280	4510004650	S.ELECTROLYTIC ECEV1EA4R7SR
C281	4030011340	S.CERAMIC C1608 CH 1H 471J-T
C282	4030011600	S.CERAMIC C1608 JB 1E 104K-T
C283	4030006860	S.CERAMIC C1608 JB 1H 102K-T
C284	4030006900	S.CERAMIC C1608 JB 1H 103K-T
C286	4030011600	S.CERAMIC C1608 JB 1E 104K-T
C287	4030006860	S.CERAMIC C1608 JB 1H 102K-T
C288	4030011600	S.CERAMIC C1608 JB 1E 104K-T
C289	4030011600	S.CERAMIC C1608 JB 1E 104K-T
C290	4030006860	S.CERAMIC C1608 JB 1H 102K-T
C291	4030006860	S.CERAMIC C1608 JB 1H 102K-T
C292	4030007090	S.CERAMIC C1608 CH 1H 470J-T
C293	4030006860	S.CERAMIC C1608 JB 1H 102K-T
C294	4030006860	S.CERAMIC C1608 JB 1H 102K-T
C295	4510004630	S.ELECTROLYTIC ECEV1CA100SR
C296	4030011600	S.CERAMIC C1608 JB 1E 104K-T
C297	4030009910	S.CERAMIC C1608 CH 1H 040B-T
	4030007020	S.CERAMIC C1608 CH 1H 120J-T
C298	4030006980	S.CERAMIC C1608 CH 1H 070D-T
	4030011770	S.CERAMIC C1608 CH 1H 060B-T
C299	4030006980	S.CERAMIC C1608 CH 1H 070D-T
	4030011770	S.CERAMIC C1608 CH 1H 060B-T
C300	4030006860	S.CERAMIC C1608 JB 1H 102K-T
C301	4030011340	S.CERAMIC C1608 CH 1H 471J-T
C302	4030007010	S.CERAMIC C1608 CH 1H 100D-T
C303	4030006860	S.CERAMIC C1608 JB 1H 102K-T
C304	4030007010	S.CERAMIC C1608 CH 1H 100D-T
C305	4030007100	S.CERAMIC C1608 CH 1H 560J-T
C306	4030009910	S.CERAMIC C1608 CH 1H 040B-T
C307	4030006980	S.CERAMIC C1608 CH 1H 070D-T
C308	4030009530	S.CERAMIC C1608 CH 1H 030B-T
C309	4030006900	S.CERAMIC C1608 JB 1H 103K-T
C310	4030011600	S.CERAMIC C1608 JB 1E 104K-T
C311	4030011600	S.CERAMIC C1608 JB 1E 104K-T
C313	4030007090	S.CERAMIC C1608 CH 1H 470J-T
C314	4030006900	S.CERAMIC C1608 JB 1H 103K-T
C315	4030008880	S.CERAMIC C1608 JB 1H 223K-T
C316	4030009490	S.CERAMIC C1608 JB 1H 821K-T
C317	4030009490	S.CERAMIC C1608 JB 1H 821K-T
C318	4030011600	S.CERAMIC C1608 JB 1E 104K-T
C319	4030008920	S.CERAMIC C1608 JB 1H 473K-T
C320	4030008910	S.CERAMIC C1608 JB 1H 393K-T
C321	4030011600	S.CERAMIC C1608 JB 1E 104K-T
C322	4030006900	S.CERAMIC C1608 JB 1H 103K-T
C323	4030009880	S.CERAMIC C1608 JB 1H 682K-T
C324	4030011600	S.CERAMIC C1608 JB 1E 104K-T
C325	4030008650	S.CERAMIC C1608 JB 1H 332K-T
C327	4510004650	S.ELECTROLYTIC ECEV1EA4R7SR
C328	4030017490	S.CERAMIC C1608 JB 1A 105K-T
C329	4030008870	S.CERAMIC C1608 JB 1H 183K-T
C330	4030007110	S.CERAMIC C1608 CH 1H 680J-T
C331	4030006900	S.CERAMIC C1608 JB 1H 103K-T
C332	4030017490	S.CERAMIC C1608 JB 1A 105K-T
C333	4030006860	S.CERAMIC C1608 JB 1H 102K-T
C334	4030009630	S.CERAMIC C1608 JB 1H 822K-T
C335	4030008920	S.CERAMIC C1608 JB 1H 473K-T
C336	4030009490	S.CERAMIC C1608 JB 1H 821K-T
C337	4030017480	S.CERAMIC C1608 JB 1A 474K-T
C338	4030006900	S.CERAMIC C1608 JB 1H 103K-T
C339	4030007060	S.CERAMIC C1608 CH 1H 270J-T
C340	4030006900	S.CERAMIC C1608 JB 1H 103K-T
C341	4030007020	S.CERAMIC C1608 CH 1H 120J-T
C342	4030007050	S.CERAMIC C1608 CH 1H 220J-T
C343	4030011600	S.CERAMIC C1608 JB 1E 104K-T
C344	4030008890	S.CERAMIC C1608 JB 1H 273K-T
C345	4030011600	S.CERAMIC C1608 JB 1E 104K-T
C347	4510006260	S.ELECTROLYTIC ECEV1AA471UP
C348	4030006860	S.CERAMIC C1608 JB 1H 102K-T
C349	4030011600	S.CERAMIC C1608 JB 1E 104K-T
C350	4030017490	S.CERAMIC C1608 JB 1A 105K-T
C351	4030008920	S.CERAMIC C1608 JB 1H 473K-T
C352	4510005430	S.ELECTROLYTIC ECEV0JA220SR
C353	4030007090	S.CERAMIC C1608 CH 1H 470J-T
C354	4030006850	S.CERAMIC C1608 JB 1H 471K-T
C355	4010005420	CERAMIC HM60SJ CH 040C 500V
C356	4010005450	CERAMIC HM60SJ CH 070D 500V
C357	4010005730	CERAMIC HM60SJ SL 470J 500V
C358	4030007090	S.CERAMIC C1608 CH 1H 470J-T
C359	4030011600	S.CERAMIC C1608 JB 1E 104K-T
C360	4030011600	S.CERAMIC C1608 JB 1E 104K-T
C361	4030010020	S.CERAMIC C1608 JB 1H 122K-T
C362	4030011600	S.CERAMIC C1608 JB 1E 104K-T

[L]
[M], [H]
[L]
[M], [H]
[L]
[M], [H]

S.=Surface mount

[MAIN UNIT]

REF NO.	ORDER NO.	DESCRIPTION	
C363	4030006980	S.CERAMIC	C1608 CH 1H 070D-T
C364	4030006980	S.CERAMIC	C1608 CH 1H 070D-T
C365	4030009920	S.CERAMIC	C1608 CH 1H 050B-T
C366	4030011600	S.CERAMIC	C1608 JB 1E 104K-T
C367	4030007090	S.CERAMIC	C1608 CH 1H 470J-T
C368	4550002890	S.TANTALUM	TESVA 1A 225M1-8L
C369	4030007090	S.CERAMIC	C1608 CH 1H 470J-T
C370	4030007090	S.CERAMIC	C1608 CH 1H 470J-T
C371	4030006900	S.CERAMIC	C1608 JB 1H 103K-T
C372	4550002890	S.TANTALUM	TESVA 1A 225M1-8L
C373	4030006860	S.CERAMIC	C1608 JB 1H 102K-T
C374	4030009920	S.CERAMIC	C1608 CH 1H 050B-T
C375	4030006860	S.CERAMIC	C1608 JB 1H 102K-T
C376	4030006860	S.CERAMIC	C1608 JB 1H 102K-T
C377	4030011600	S.CERAMIC	C1608 JB 1E 104K-T
C378	4030006860	S.CERAMIC	C1608 JB 1H 102K-T
C379	4030007050	S.CERAMIC	C1608 CH 1H 220J-T
C380	4030006860	S.CERAMIC	C1608 JB 1H 102K-T
C381	4030007050	S.CERAMIC	C1608 CH 1H 220J-T
C382	4030006860	S.CERAMIC	C1608 JB 1H 102K-T
C383	4030007050	S.CERAMIC	C1608 CH 1H 220J-T
C384	4030007050	S.CERAMIC	C1608 CH 1H 220J-T
C385	4030006860	S.CERAMIC	C1608 JB 1H 102K-T
C386	4030011600	S.CERAMIC	C1608 JB 1E 104K-T
C387	4030011600	S.CERAMIC	C1608 JB 1E 104K-T
C388	4030017490	S.CERAMIC	C1608 JB 1A 105K-T
C389	4510005630	S.ELECTROLYTIC	ECEV1EA330SP
	4510005750	S.ELECTROLYTIC	ECEV1EA220SP
C390	4030007050	S.CERAMIC	C1608 CH 1H 220J-T
C391	4030007170	S.CERAMIC	C1608 CH 1H 221J-T
C392	4030006860	S.CERAMIC	C1608 JB 1H 102K-T
C393	4030007050	S.CERAMIC	C1608 CH 1H 220J-T
C394	4030007170	S.CERAMIC	C1608 CH 1H 221J-T
C395	4030006860	S.CERAMIC	C1608 JB 1H 102K-T
C396	4030007050	S.CERAMIC	C1608 CH 1H 220J-T
C397	4030007170	S.CERAMIC	C1608 CH 1H 221J-T
C398	4030006860	S.CERAMIC	C1608 JB 1H 102K-T
C399	4030011600	S.CERAMIC	C1608 JB 1E 104K-T
C400	4030009500	S.CERAMIC	C1608 CH 1H 0R5B-T
C401	4030007050	S.CERAMIC	C1608 CH 1H 220J-T
C402	4030017480	S.CERAMIC	C1608 JB 1A 474K-T
C403	4030006860	S.CERAMIC	C1608 JB 1H 102K-T
J1	6510018430	S.CONNECTOR	AXN330C038P
J2	6510023090	S.CONNECTOR	20FLT-SM1-TB
J4	6450000140	CONNECTOR	HSJ0807-01-010
J5	6510007080	CONNECTOR	PI28A-02M
J6	6510019250	S.CONNECTOR	B11B-ZR-SM3-TF
J8	6510021300	S.CONNECTOR	52365-1091
J9	6510021300	S.CONNECTOR	52365-1091
W1	7120000470	JUMPER	ERDS2T0
W2	8900004540	CABLE	OPC-453
EP1	6910013370	S.BEAD	BLM18BB221SN1D
EP2	6910011560	BEAD	HF70BB4.5X5X1.6
EP3	6910010280	BEAD	HF70BB9.5X10.4X4.9
EP4	0910054925	PCB	B 5808E

[L]
[M], [H]

[45W]

S.=Surface mount

SECTION 7 MECHANICAL PARTS

[CHASSIS PARTS]

REF. NO.	ORDER NO.	DESCRIPTION	QTY.
J1	6510004880	Connector MR-DS-E 01	1
SP1	2510001030	Speaker VS-57-0837A	1
WS1	8600036860	Cable FX2527 P01CH	1
MP1	8010018880	2526 chassis	1
MP2	8010018902	2055 cover (A)-2	1
MP3	8210018571	2526 front panel-1	1
MP4	8930057090	2526 front key	1
MP5	8610011180	Knob N292	1
MP6	8610007420	Knob spring	1
MP7	8930044761	2055 SP net-1	1
MP8	8930044100	2055 SP plate	1
MP9	8930027480	1126 TR-A clip	1
MP11	8810008660	Screw PH BT M3 × 8 NI-ZU	15
MP12	8810008760	Screw PH BT M2 × 8 NI-ZU	4
MP13	8810009990	Screw PH BT M3 × 8 ZK	6
MP14	8930057890	Non-woven sheet (CF)	1
MP15	8930057940	Shield sponge (N) [EUR] only	1

[MAIN UNIT]

REF. NO.	ORDER NO.	DESCRIPTION	QTY.
J4	6450000140	Connector HSJ0807-01-010	1
W2	8900004540	Cable OPC-453	1
MP1	8930045070	2055 M-plate	1
MP2	8510011111	1922 VCO case-1	1
MP3	8510011180	1923 VCO cover	1
MP4	8510011460	2055 filter case	1
MP5	8510011610	2055 filter cover (A)	1
MP6	8930057900	2526 module holder assembly	1
MP8	8930045390	Sponge (FL)	1
MP11	8510014220	2055 SP-A plate [EUR] only	1
MP12	8930056510	2055 shield plate	1
MP13	8510005070	599 sheild plate	1
MP14	8930046150	Rubber sheet (AK)-1	1
MP15	8930057730	Shield sponge (J)	1
MP16	8930057730	Shield sponge (J)	1
MP17	8930057830	Shield sponge (L)	1
MP19	8930046770	Thermally sheet (G) [45W] only	1
MP20	8930058610	Insulate plate (HD)	1

[FRONT UNIT]

REF. NO.	ORDER NO.	DESCRIPTION	QTY.
R12	7210003020	Variable resistor EVU-F2KFK1	1
J1	6450002210	Connector 3017-8821	1
DS12	5030002230	LCD L1-0483TAT	1
W1	8900010950	Cable OPC-1126	1
EP2	8930057820	LCD contact SRCN-2526-SP-N-W	1
MP1	8210018630	2526 reflector	1
MP2	8930057150	2526 LCD holder	1
MP3	8930057140	2526 earth plate	2
MP4	8930057650	2526 LCD filter	1

[ACCESSORY PARTS]

REF. NO.	ORDER NO.	DESCRIPTION	QTY.
F1	5210000120	Fuse FGB 15A [25W]	2
	5210000080	Fuse FGB 20A [45W]	2
MC1	Optional product	Microphone HM-100N	1
W1	Optional product	Cable OPC-345 [25W]	1
	Optional product	Cable OPC-346 [45W]	1
W2	Optional product	Cable OPC-049	1
MP1	8010016380	1542 mobil bracket (B)	1
MP3	8820000530	Flange volt M4 × 8 NI	4
MP4	8810000470	Screw PH M5 × 12 (+)	4
MP5	8810005840	Screw PH A M5 × 20	4
MP6	8850000150	Flat washer M5 NI BS	4
MP7	8850000390	Spring washer M5	4
MP8	8830000120	Nut M5	4
MP9	6910004210	731 mic hanger set	1
MP10	8310053310	Label 1705 LCD seal (D) [CONV]	1
	8310054140	Label 1705 LCD seal (E) [MPT]	1

Screw abbreviations BT: Self-tapping PH: Pan head
 ZK: Black BS: Brass
 NI: Nickel NI-ZU: Nickel-Zinc

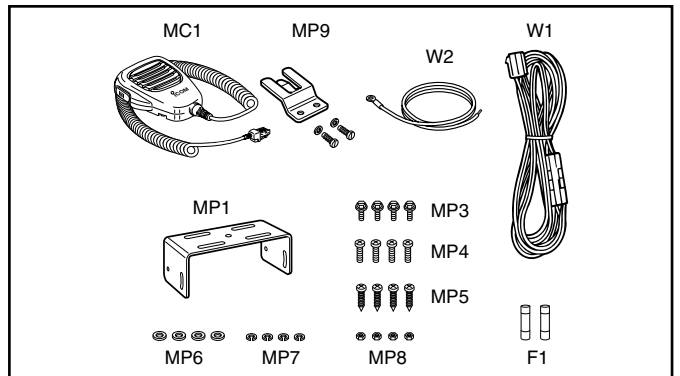

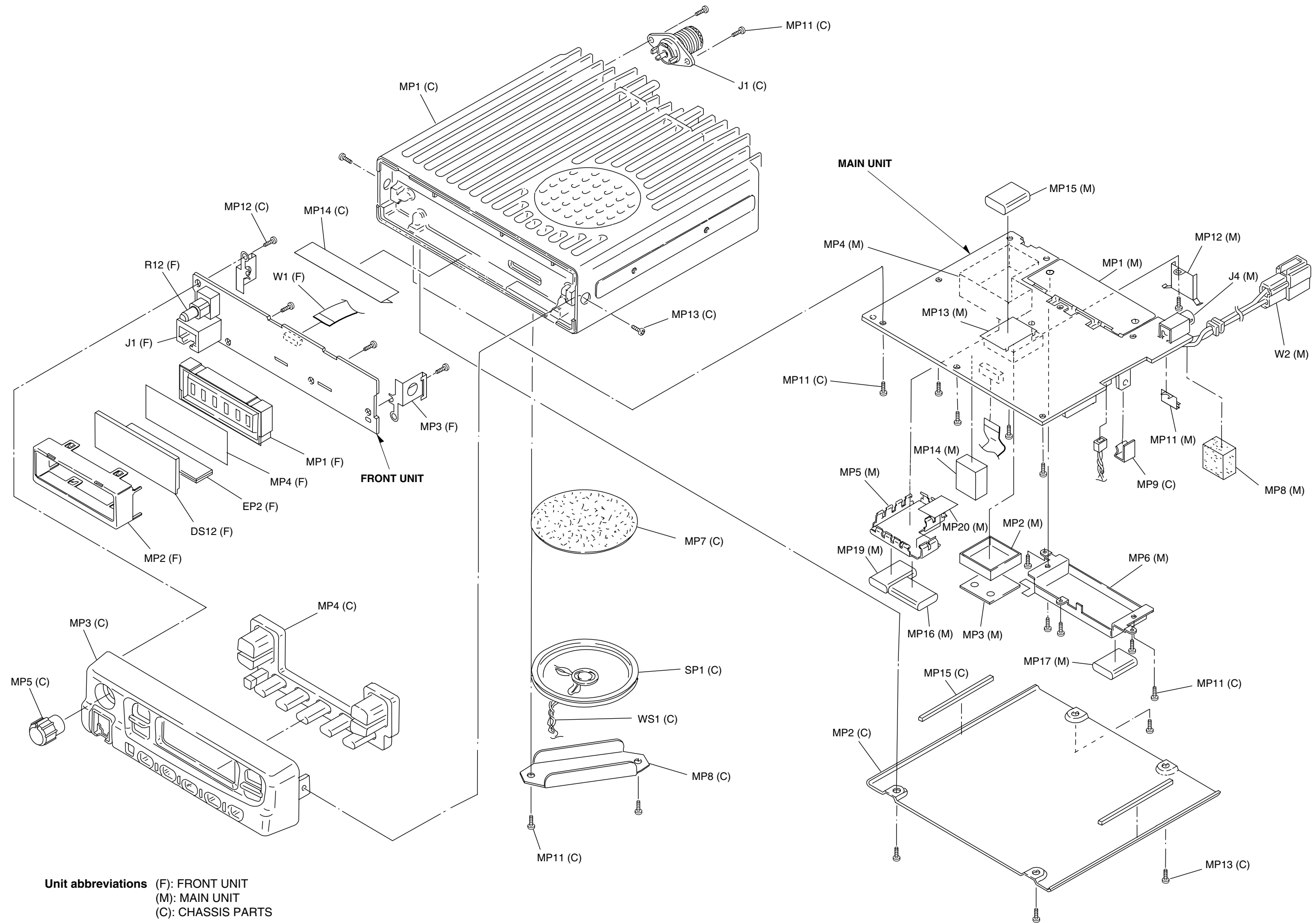

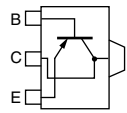
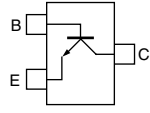
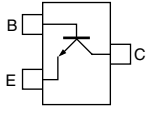
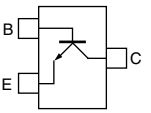
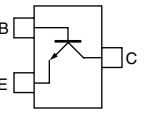
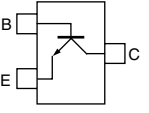
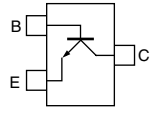
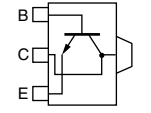
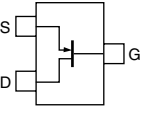
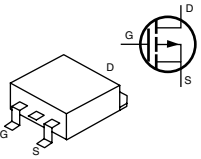
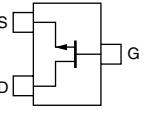
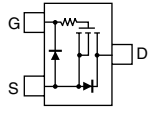
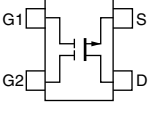
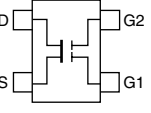
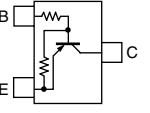
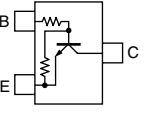
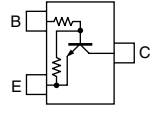
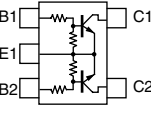
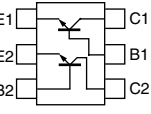

SECTION 8 SEMI-CONDUCTOR INFORMATION

• TRANSISTORS AND FET'S

2SB1132 T100 R (Symbol: BAR) 	2SC3356 R24 T2B (Symbol: R24) 	2SC4116 BL (Symbol: LL) 	2SC4213 B (Symbol: AB) 	2SC4215 O (Symbol: QO) 
2SC4226 T1 R25 (Symbol: R25) 	2SC5107 O (Symbol: MFO) 	2SD1664 T100Q (Symbol: DAQ) 	2SJ144 GR (Symbol: VG) 	2SJ377 (Symbol: 4L) 
2SK880 Y (Symbol: XY) 	2SK1829 (Symbol: K1) 	3SK272 (Symbol: K) 	3SK293 (Symbol: UF) 	DTA144EUA T106 (Symbol: 16) 
DTC144EUA T106 (Symbol: 26) 	DTC363 EK (Symbol: H27) 	XP1214 (Symbol: 9H) 	XP6501 AB (Symbol: 5N) 	

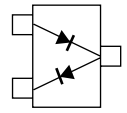
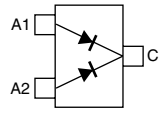
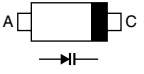
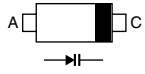
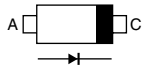
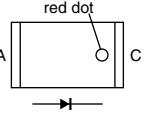
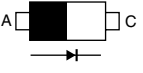
• DIODES

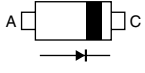
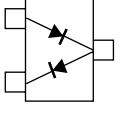
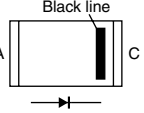
DA221 TL (Symbol: K) 	DAN222TL (Symbol: N) 	HVC350B (Symbol: B0) 	HVC362 (Symbol: V2) 	MA2S111 (Symbol: A) 
MA4PH224 (Symbol: None) 	MA77 (Symbol: 4B) 	MA368 (Symbol: 6L) 	MA728 (Symbol: 2A) 	RB706F-40 T106 (Symbol: 3J) 
UM9401F (Symbol: None) 				

SECTION 9 BOARD LAYOUTS

9-1 FRONT UNIT • TOP VIEW

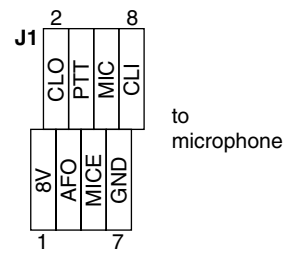
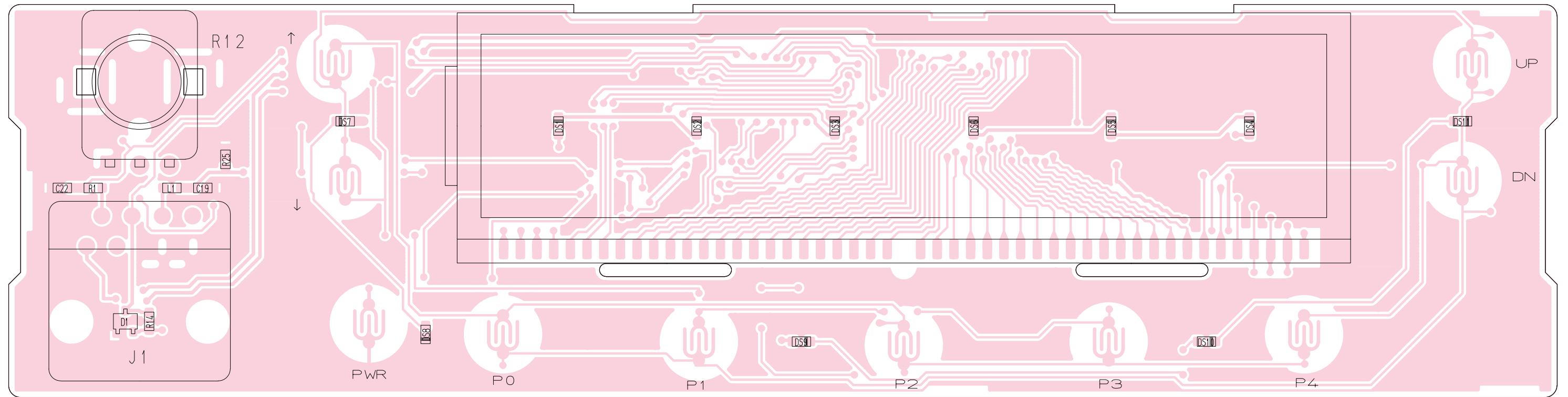

• BOTTOM VIEW (FRONT UNIT)

to MAIN unit J2

1	8V	19
2	5V	20
	KR0	
	KR1	
	KR2	
	FSW	
	HORN	
	CLO	
	PTT	
	AFO	
	GND	
	MIC	

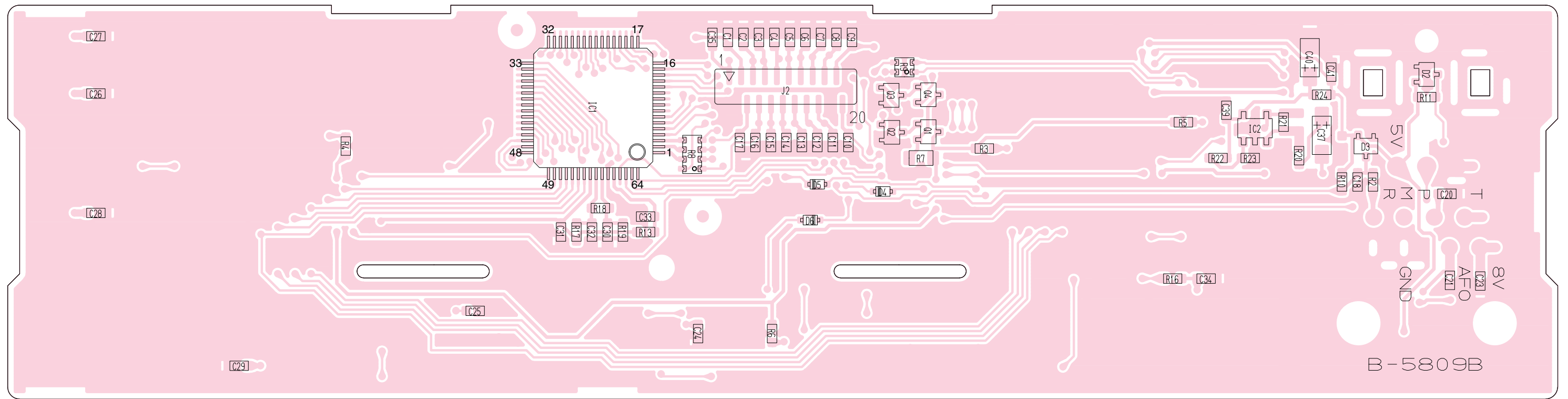

• BOTTOM VIEW (MAIN UNIT)

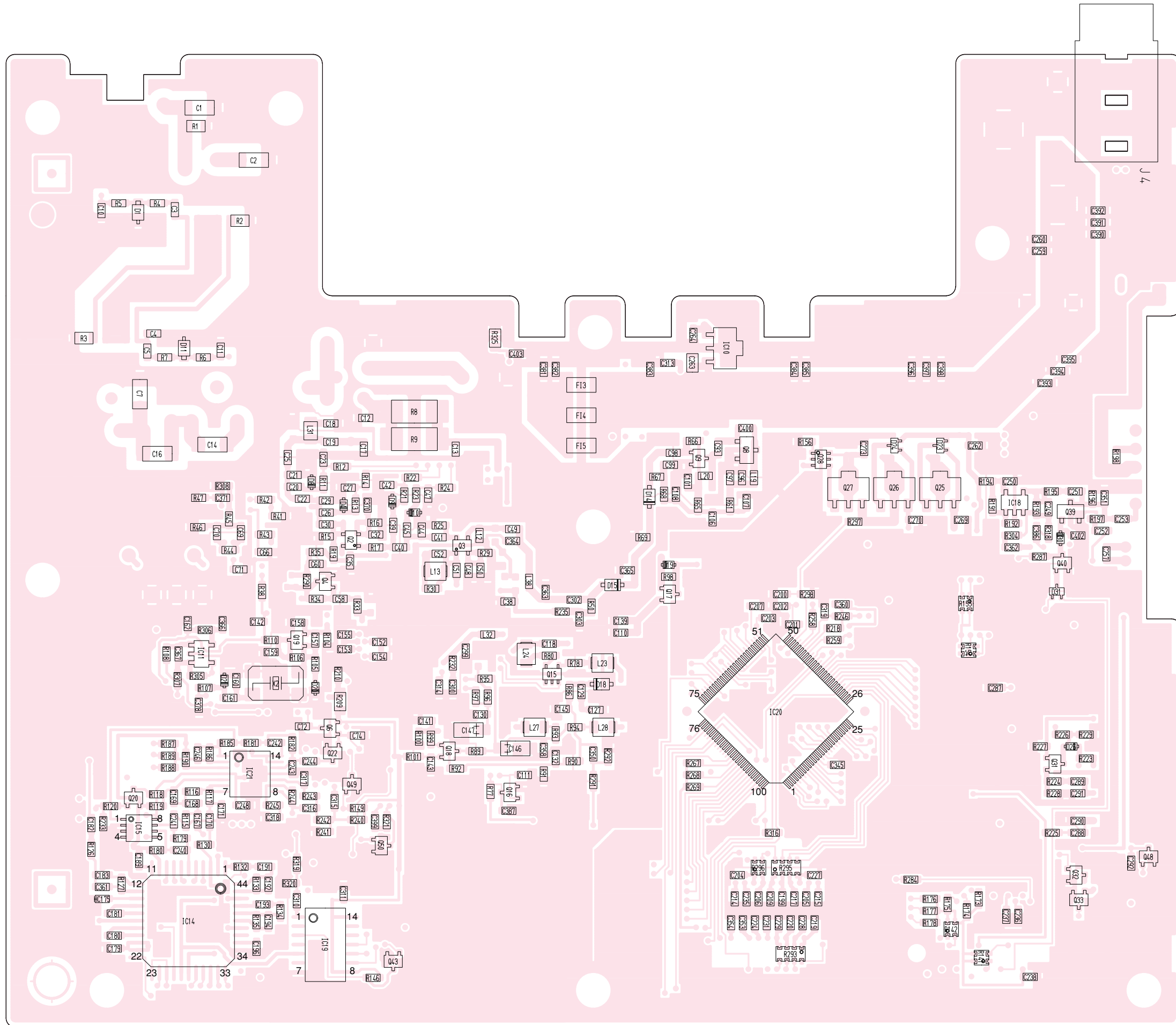

SECTION 10 BLOCK DIAGRAM

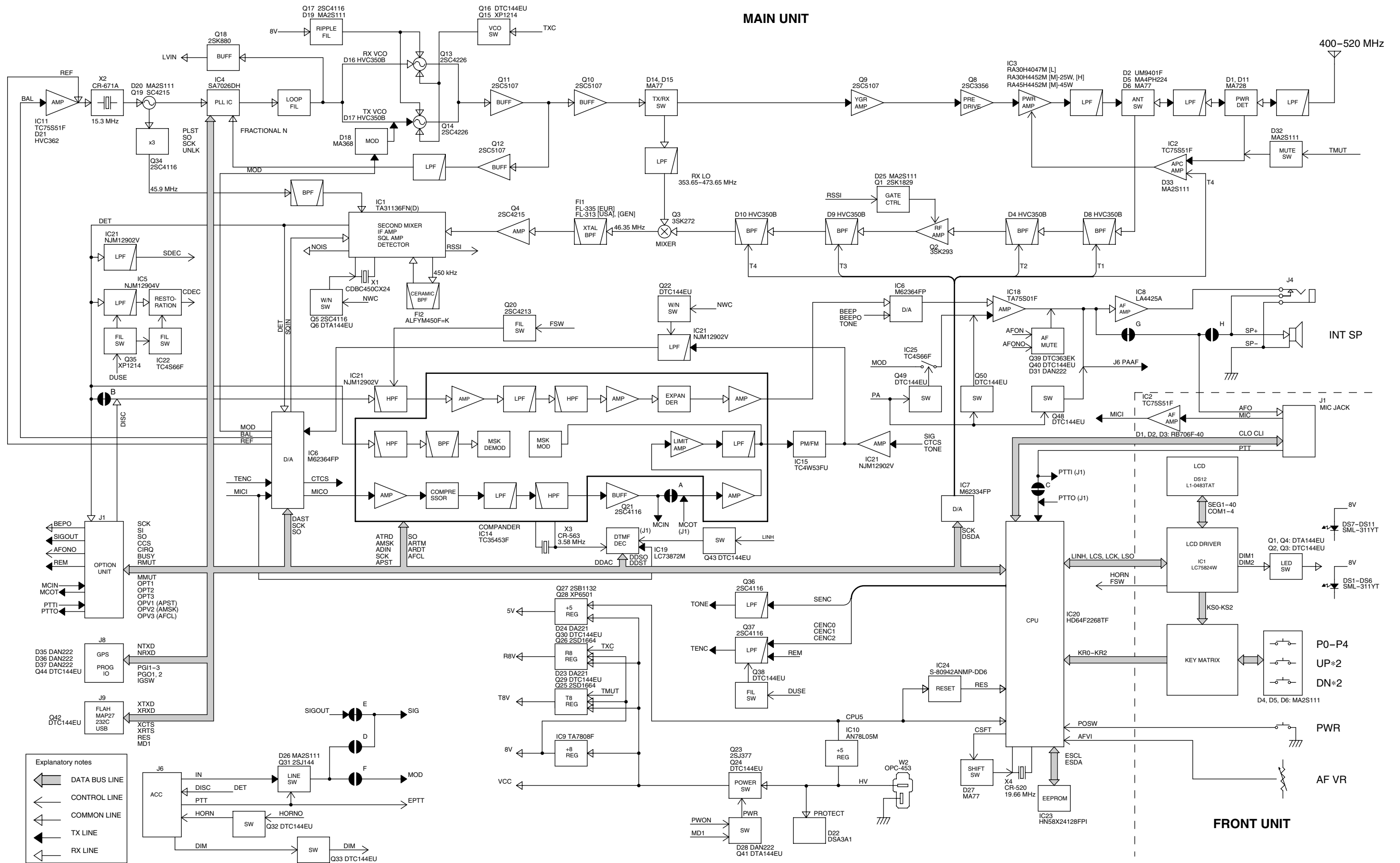

SECTION 11 VOLTAGE DIAGRAMS

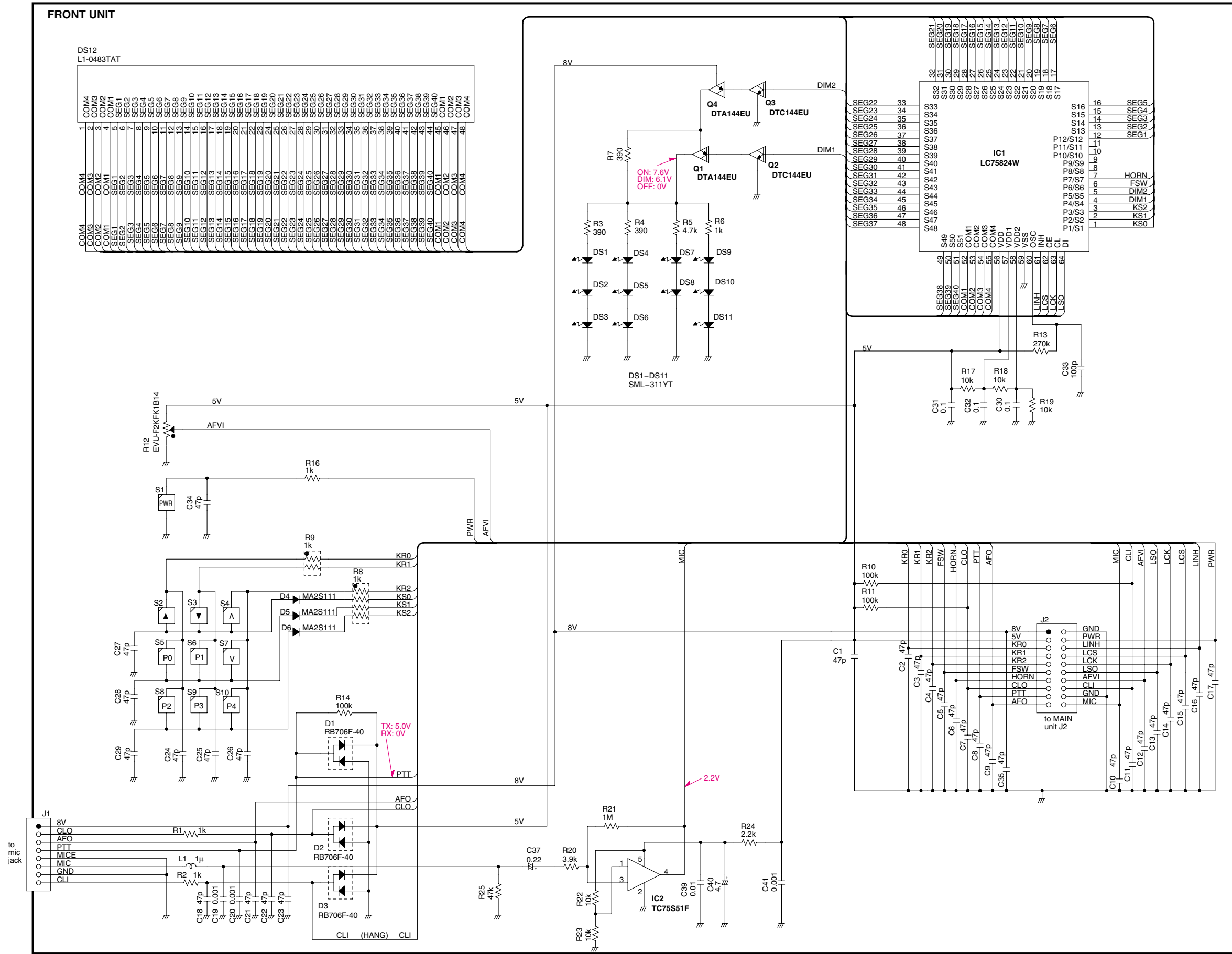

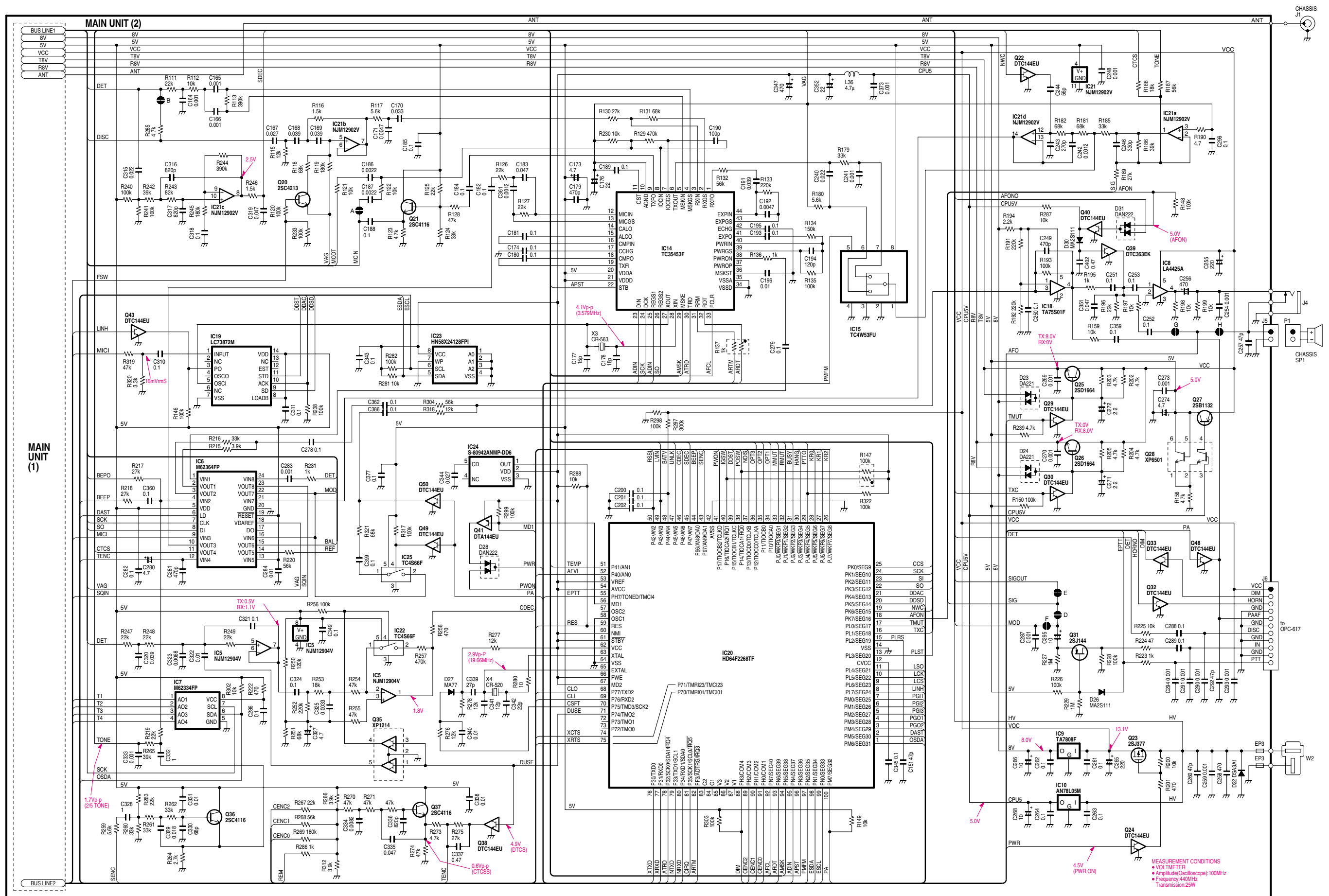

MEASUREMENT CONDITIONS
 • VOLT METER
 • Amplitude (Oscilloscope) 100mV
 • Frequency 440kHz
 • Transmission 25W

Icom Inc.

1-1-32, Kamiminami, Hirano-ku, Osaka 547-0003, Japan
Phone : +81 (06) 6793 5302
Fax : +81 (06) 6793 0013
URL : <http://www.icom.co.jp/world/index.html>

Icom America Inc.

<Corporate Headquarters>
2380 116th Avenue N.E., Bellevue, WA 98004, U.S.A.
Phone : +1 (425) 454-8155 Fax : +1 (425) 454-1509
URL : <http://www.icomamerica.com>
E-mail : sales@icomamerica.com
<Customer Service>
Phone : +1 (425) 454-7619

Icom Canada

Glenwood Centre #150-6165
Highway 17 Delta, B.C., V4K 5B8, Canada
Phone : +1 (604) 952-4266 Fax : +1 (604) 952-0090
URL : <http://www.icomcanada.com>
E-mail : info@icomcanada.com

Icom (Australia) Pty. Ltd.

A.B.N. 88 006 092 575
290-294 Albert Street, Brunswick, Victoria, 3056, Australia
Phone : +61 (03) 9387-0666 Fax : +61 (03) 9387-0022
URL : <http://www.icom.net.au>
E-mail : sales@icom.net.au

Icom New Zealand

146A Harris Road, East Tamaki,
Auckland, New Zealand
Phone : +64 (09) 274 4062 Fax : +64 (09) 274 4708
URL : <http://www.icom.co.nz>
E-mail : inquiries@icom.co.nz

Beijing Icom Ltd.

1305, Wanshang Plaza, Shijingshan Road, Beijing China
Phone : +86 (010) 6866 6337 Fax : +86 (010) 6866 3553
URL : <http://www.bjicom.com>
E-mail : bjicom@bjicom.com

Icom (Europe) GmbH

Communication Equipment
Himmelgeister Str. 100, D-40225 Düsseldorf, Germany
Phone : +49 (0211) 346047 Fax : +49 (0211) 333639
URL : <http://www.icomeurope.com>
E-mail : info@icomeurope.com

Icom Spain S.L

Crta. de Gracia a Manresa Km. 14.750
08190 Sant Cugat del Valles Barcelona, SPAIN
Phone : +34 (93) 590 26 70 Fax : +34 (93) 589 04 46
URL : <http://www.icomspain.com>
E-mail : icom@icomspain.com

Icom (UK) Ltd.

Unit 9, Sea St., Heme Bay, Kent, CT6 8LD, U.K.
Phone : +44 (01227) 741741 Fax : +44 (01227) 741742
URL : <http://www.icomuk.co.uk>
E-mail : info@icomuk.co.uk

Icom France S.a

Zac de la Plaine, 1, Rue Brindejonc des Moulinais
BP 5804, 31505 Toulouse Cedex, France
Phone : +33 (5) 61 36 03 03 Fax : +33 (5) 61 36 03 00
URL : <http://www.icom-france.com>
E-mail : icom@icom-france.com

Asia Icom Inc.

6F No.68, Sec. 1 Cheng-Teh Road, Taipei, Taiwan, R.O.C.
Phone : +886 (02) 2559 1899 Fax : +886 (02) 2559 1874
URL : <http://www.asia-icom.com>
E-mail : sales@asia-icom.com

Icom Polska

Sopot, 3 Maja 54 Poland
Phone : +48 (58) 550 7135 Fax : +48 (58) 551 0484
E-mail : icompolska@icompolska.com.pl

Count on us!

Icom Inc.

1-1-32, Kamiminami, Hirano-ku, Osaka 547-0003, Japan

S-13817HZ-C1U-①

© 2002 Icom Inc.